

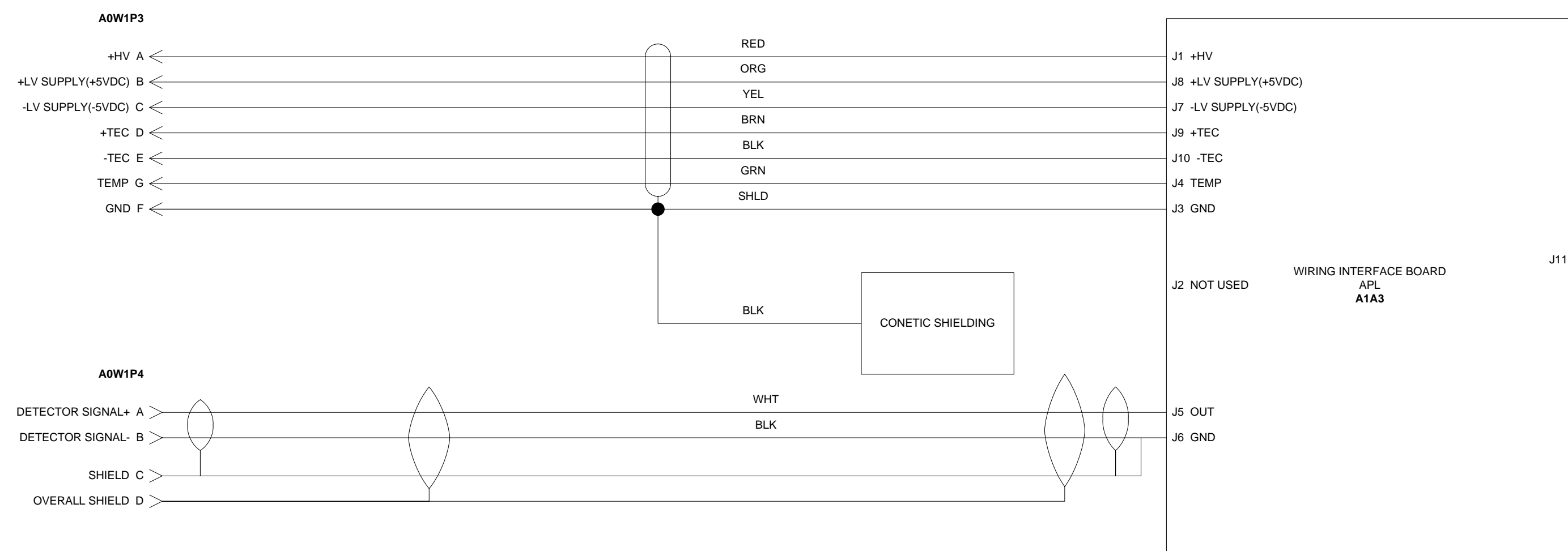

**NOTE:
CONTACT
ORDERING NOT
SEQUENTIAL**

**NOTE:
CONTACT ORDERING NOT SEQUENTIAL
ON J1-J10**



CONTRACT NO.		 APPLIED PHYSICS LABORATORY UNIVERSITY OF WASHINGTON SEATTLE WASHINGTON	
XRF HEAD UMBILICAL, SCHEMATIC A0W1, SYSTEM LEVEL, BOREHOLE XRF PROTOTYPE			
DRAWN BY	SIZE	CAGE CODE	DWG NO
LIGHT	D	98514	XXXXX
FILENAME	DATE	SHEET	REV
BOREHOLE XRF PROTOTYPE CABLE ASSEMBLY DIAGRAMS REV1.14 VSD	22AUG07	1	1 OF 1

8 7 6 5 4 3 2 1

H
G
F
E
D
C
B
A

A1A3 WIRING DETAIL

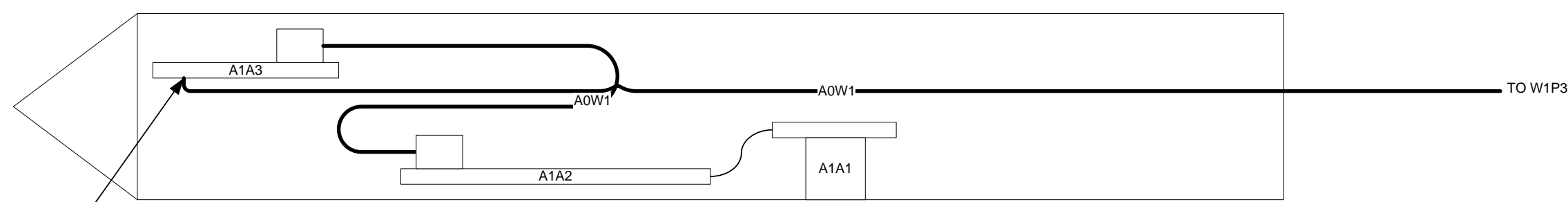

WIRING TO A1A3 ARE SOLDERED CONNECTIONS TO PCB PLATE THRU HOLES.

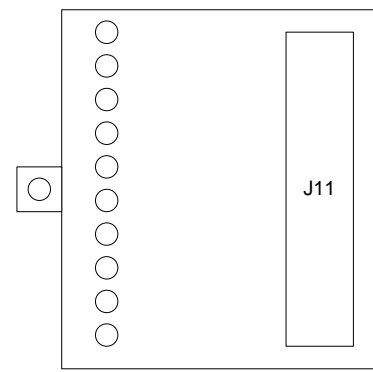

WIRING INTERFACE BOARD APL A1A3



XRF HEAD A0A1

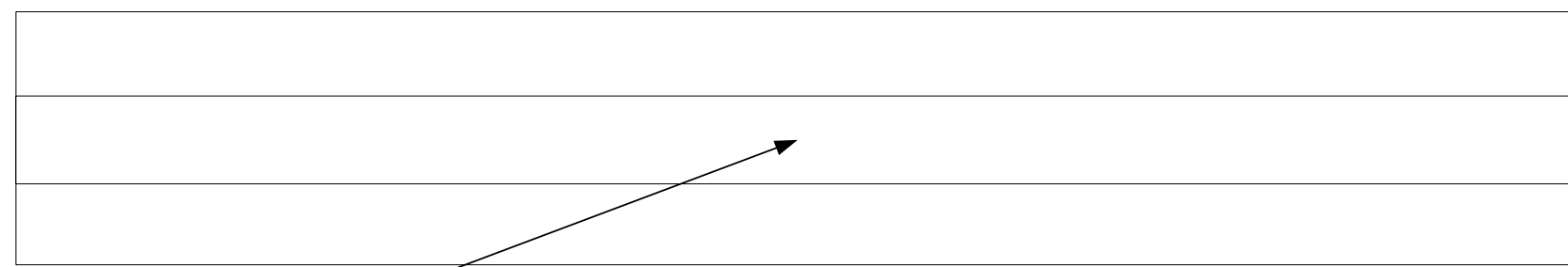

WIRES FROM W1P3 LAY IN RECESSED CHANNEL. CHANNEL IS FIRST COVERED WITH INSULATING MATERIAL THEN CONETIC SHIELDING FOIL USING CUSTOM TOOL.

WIRES ARE INSTALLED IN PVC CLEAR TUBING MCMMASTER STK# 5231K227 1/2" ID, 5/8" OD

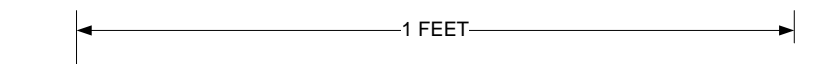
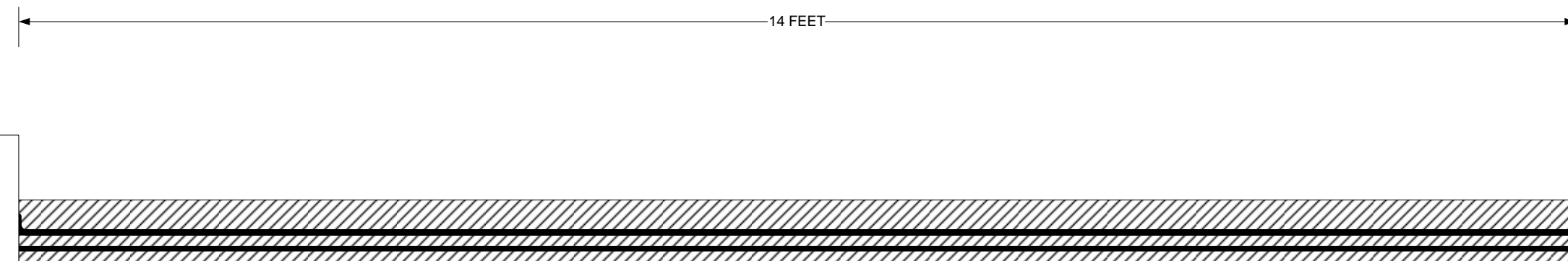

HV WIRE, RED, ULTRAVOLT W-XLPE-40KV-1001

BRAIDED SHIELD ADDED TO HV WIRE EXTENDING ALL THE WAY TO THE XRF HEAD, DRAIN WIRE ADDED AND TERMINATED TO XRF HEAD BRAID DEARBORN 92171 COVER WITH HEAT SHRINK OVER EXPOSED CABLE SECTION OUTSIDE OF TUBING

2 TSP, 22 AWG, BELDEN 8723

6 COND. + SHIELD, NATIONAL WIRE, NQ-624SJ

83317 2 CONDUCTOR SHIELDED

A0W1P1 (A2J4)

A0W1P2 (A2J5)

A0W1P3 (A2J6)

A0W1P4 (A2J7)

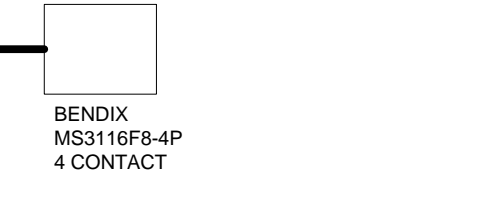
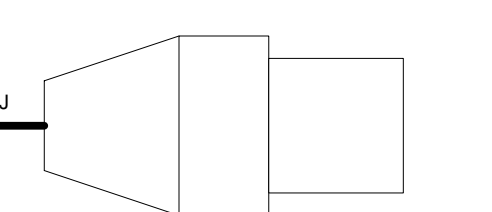
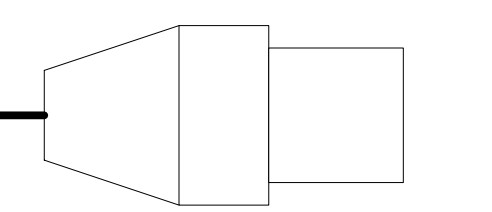
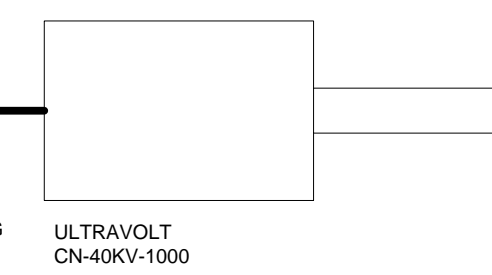

14S-6 6#16 INST.

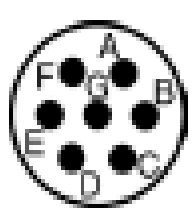

16S-1 7#16 A

NOTES
1) REFER TO "Borehole XRF Head Process Assembly RevX.X" FOR DETAILED XRF HEAD ASSEMBLY AND WIRING INFORMATION.

8 7 6 5 4 3 2 1

CONTRACT NO.		APPLIED PHYSICS LABORATORY UNIVERSITY OF WASHINGTON SEATTLE WASHINGTON	
XRF HEAD UMBILICAL, CABLE ASSY A0W1, SYSTEM LEVEL, BOREHOLE XRF PROTOTYPE			
DRAWN BY LIGHT	SIZE D	CAGE CODE 98514	DWG NO XXXXX
FILENAME BOREHOLE XRF PROTOTYPE CABLE ASSEMBLY DIAGRAMS.REV14.VSD	DATE 22AUG07	SHEET 1	REV 1 OF 3

8

7

6

5

4

3

2

1

H

H

G

G

F

F

E

E

D

D

C

C

B

B

A

A

WARNING: DO NOT SOLDER TO XRAY TUBE TERMINALS, MUST USE PUSH ON TERMINALS

.125 INCHES

USE AMP MOD IV HOUSING TERMINALS FOR T1 TO A4 CONNECTION

XRAY TUBE A4

T1 XFRM CORE

BLK 24AWG PVC

HV WIRE SHIELD DRAIN WIRE. SOLDER DRAIN WIRE 24 AWG TO SHIELD AND TERMINATE TO RING TERMINAL

1 FEET

HV WIRE, RED, ULTRAVOLT W-XLPE-40KV-1001

A0W1P1 (A2J4)

ULTRAVOLT CN-40KV-1000

TERMINAL WITH BUS WIRE FOR HV WIRE MUST CONNECT TO XRAY TUBE LEAD WITH SHORTING WIRE TO XRAY TUBE METAL END

HV WIRE IS SOLDERED TO BUS WIRE SOLDERED/ CRIMPED TO TERMINAL

BRAIDED SHIELD ADDED TO HV WIRE EXTENDING ALL THE WAY TO THE XRF HEAD. DRAIN WIRE ADDED AND TERMINATED TO XRF HEAD. BRAID DEARBORN 92171 COVER WITH HEAT SHRINK OVER EXPOSED CABLE SECTION OUTSIDE OF TUBING

USE 5 MINUTE EPOXY TO STIFFEN TERMINALS AGAINST TRANSFORMER

CONTRACT NO.		 APPLIED PHYSICS LABORATORY UNIVERSITY OF WASHINGTON SEATTLE WASHINGTON	
XRF HEAD UMBILICAL, CABLE ASSY A0W1P1 DETAIL, SYSTEM LEVEL, BOREHOLE XRF PROTOTYPE			
DRAWN BY	SIZE	CAGE CODE	DWG NO
LIGHT	D	98514	XXXXX
FILENAME	DATE	SHEET	REV
BOREHOLE XRF PROTOTYPE CABLE ASSEMBLY DIAGRAMS.REV14.VSD	10MAY07	2	2 OF 5

8

7

6

5

4

3

2

1

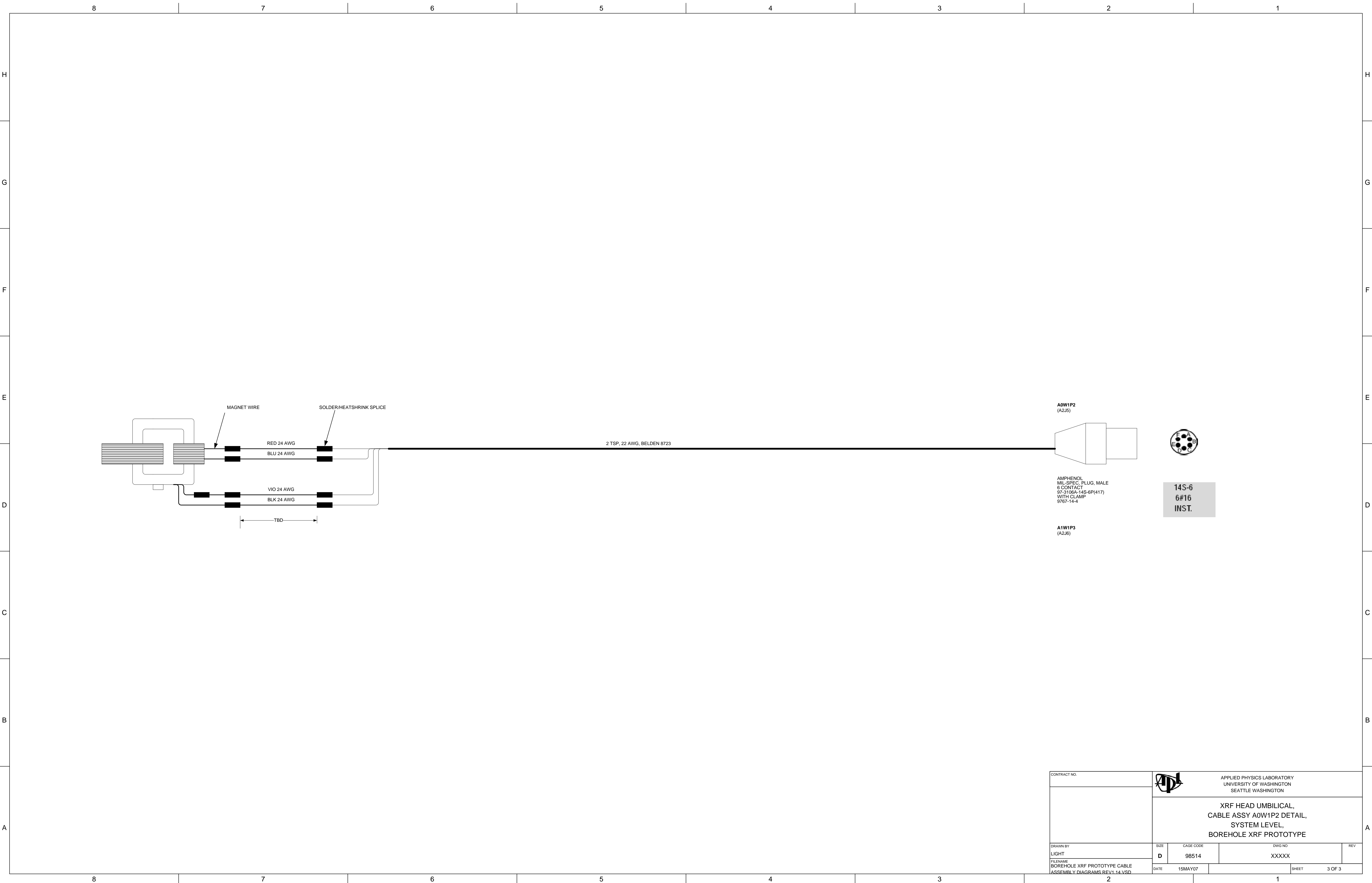

CONTRACT NO.		 APPLIED PHYSICS LABORATORY UNIVERSITY OF WASHINGTON SEATTLE WASHINGTON	
XRF HEAD UMBILICAL, CABLE ASSY A0W1P2 DETAIL, SYSTEM LEVEL, BOREHOLE XRF PROTOTYPE			
DRAWN BY	SIZE	CAGE CODE	DWG NO
LIGHT	D	98514	XXXXX
FILENAME	DATE	SHEET	REV
BOREHOLE XRF PROTOTYPE CABLE ASSEMBLY DIAGRAMS.REV14.VSD	15MAY07	1	3 OF 3

8

7

6

5

4

3

2

1

H

H

G

G

F

F

E

E

D

D

C

C

B

B

A

A

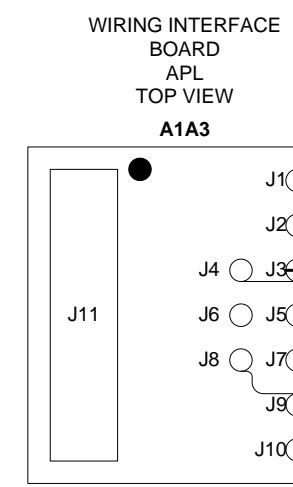

J1	+HV
J2	NOT USED
J3	GND
J4	TEMP
J5	OUT
J6	GND
J7	-LV SUPPLY(-5VDC)
J8	+LV SUPPLY (+5VDC)
J9	+TEC
J10	-TEC

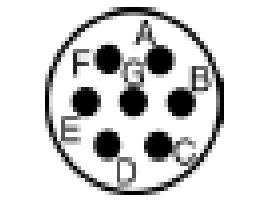
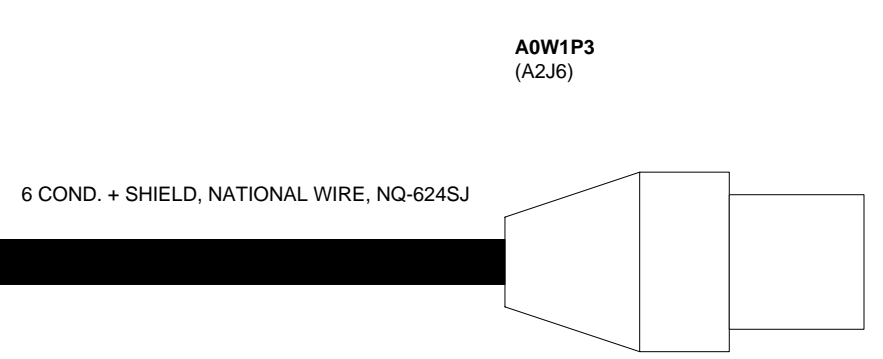
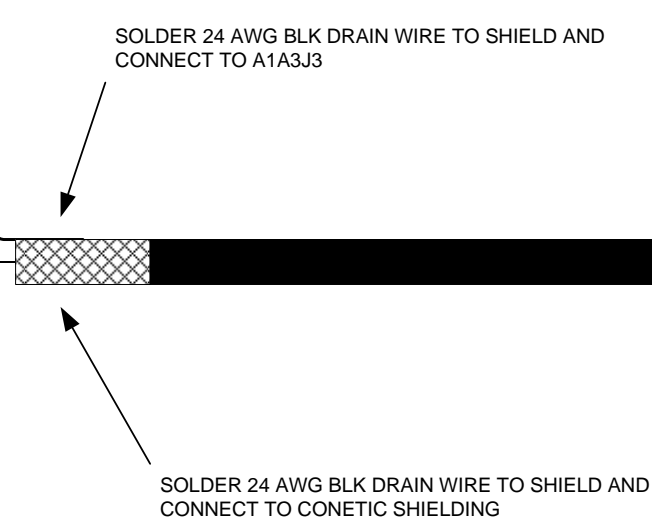
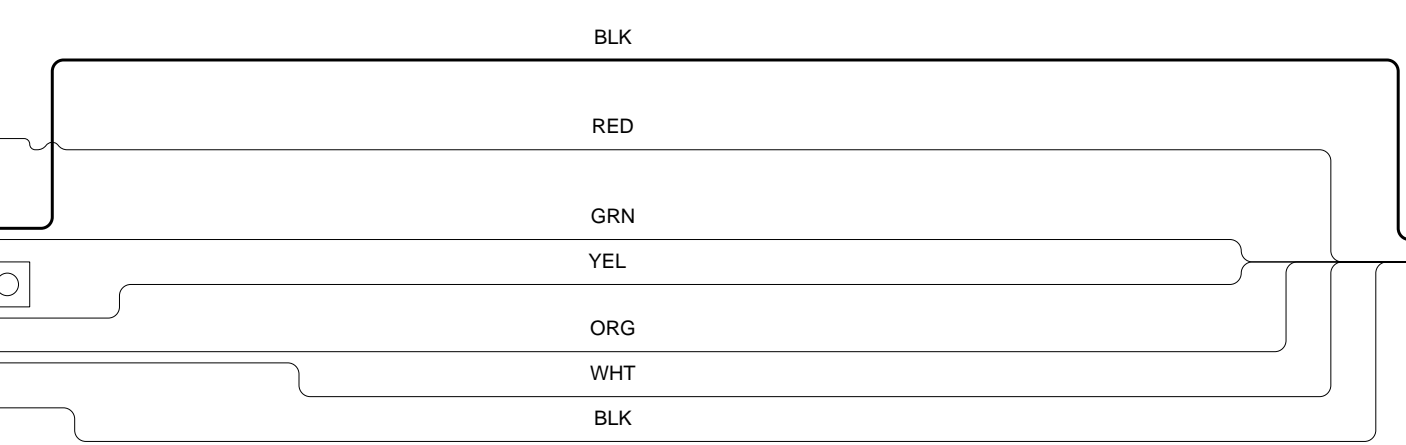

16S-1
7#16
A

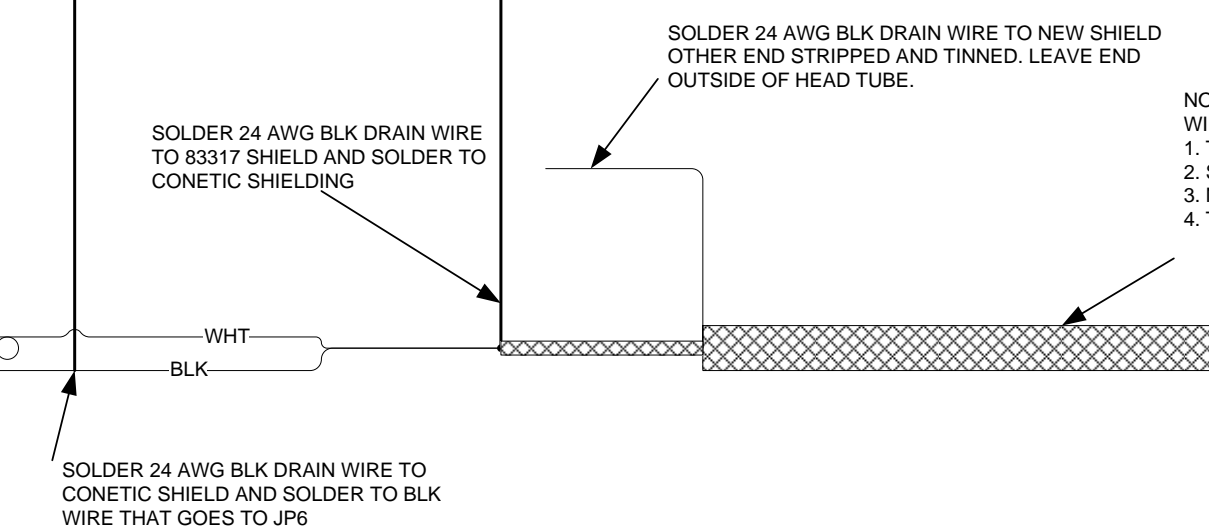
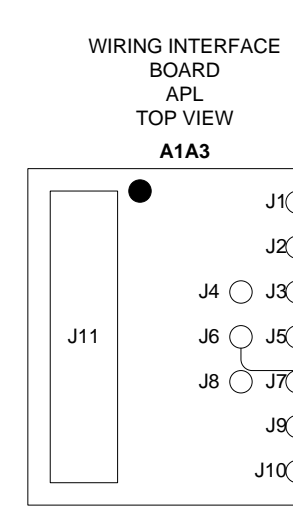

NOTE:
WIRE MADE UP WITH THE FOLLOWING:
1. TWISTED SHIELDED PAIR 83317
2. SHIELD PLACED OVER TSP 83317
3. NYLON BRAID PLACED OVER SHIELD
4. TIE TO TYGON TUBING USING HEAT SHRINK TUBING EVERY FOOT

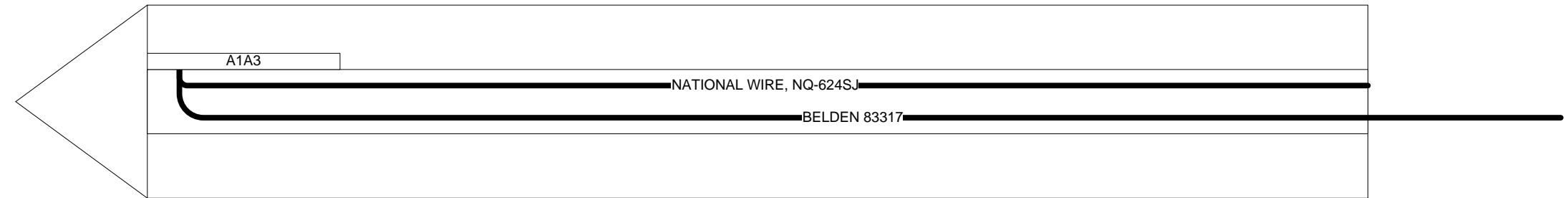
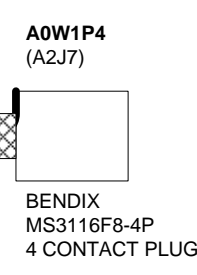
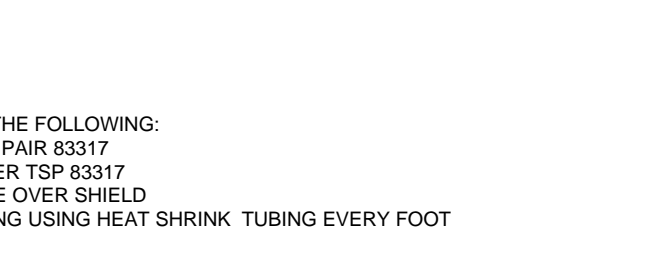

NOTES:
1) REMOVE OUTER JACKET AND SHIELD FROM NATIONAL WIRE, NQ-624SJ BEFORE ROUTING DOWN XRF HEAD CABLE CHANNEL.
2) SOLDER DRAIN WIRE, 24 AWG BLK, TO SHIELD THEN SOLDER TO BLK WIRE OF THE TWISTED WIRE THEN TO PCB.
3) INSTALL 3MIL KAPTON INSULATION INTO WIRING CHANNEL USING CUSTOM TOOL.
4) INSTALL CONETIC SHIELDING FOIL OVER KAPTON WITH CUSTOM TOOL.
5) LAY CABLES INTO CHANNEL AND FOLD OVER KAPTON AND CONETIC FOIL. HOLD IN PLACE WITH RUBBER BANDS UNTIL FINAL ASSEMBLY WITH HEAD HOUSING.

CONTRACT NO.		APPLIED PHYSICS LABORATORY UNIVERSITY OF WASHINGTON SEATTLE WASHINGTON	
XRF HEAD UMBILICAL, CABLE ASSY A0W1P3 AND A0W1P4 DETAIL, SYSTEM LEVEL, BOREHOLE XRF PROTOTYPE			
DRAWN BY	SIZE	CAGE CODE	DWG NO
LIGHT	D	98514	XXXXX
FILENAME	DATE	SHEET	REV
BOREHOLE XRF PROTOTYPE CABLE ASSEMBLY DIAGRAMS.REV14.VSD	22AUG07	1	2 OF 3

8

7

6

5

4

3

2

1

4

3

2

1

A1W1P1

A1W1P2



A1W1P1 (A1A3J11)

A1W1P2 (A1A2J1)

FLEXIBLE, FLAT RIBBON CABLE, PROVIDED BY AMPTEK, INC

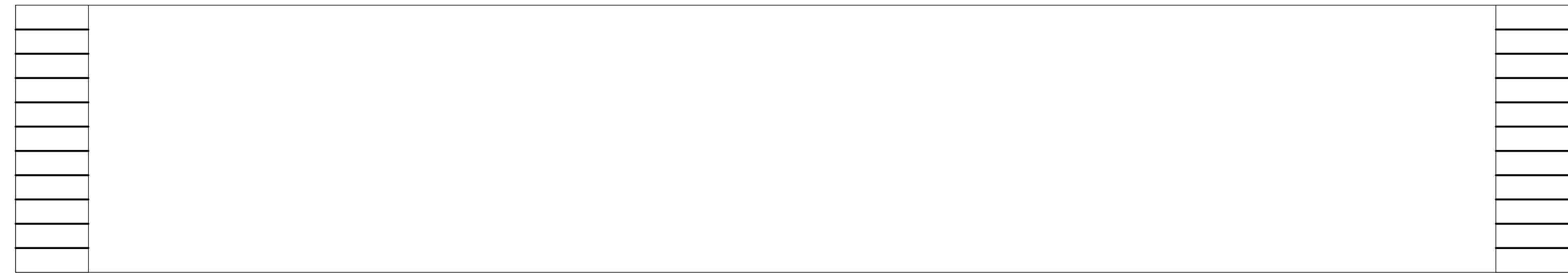

4 INCHES

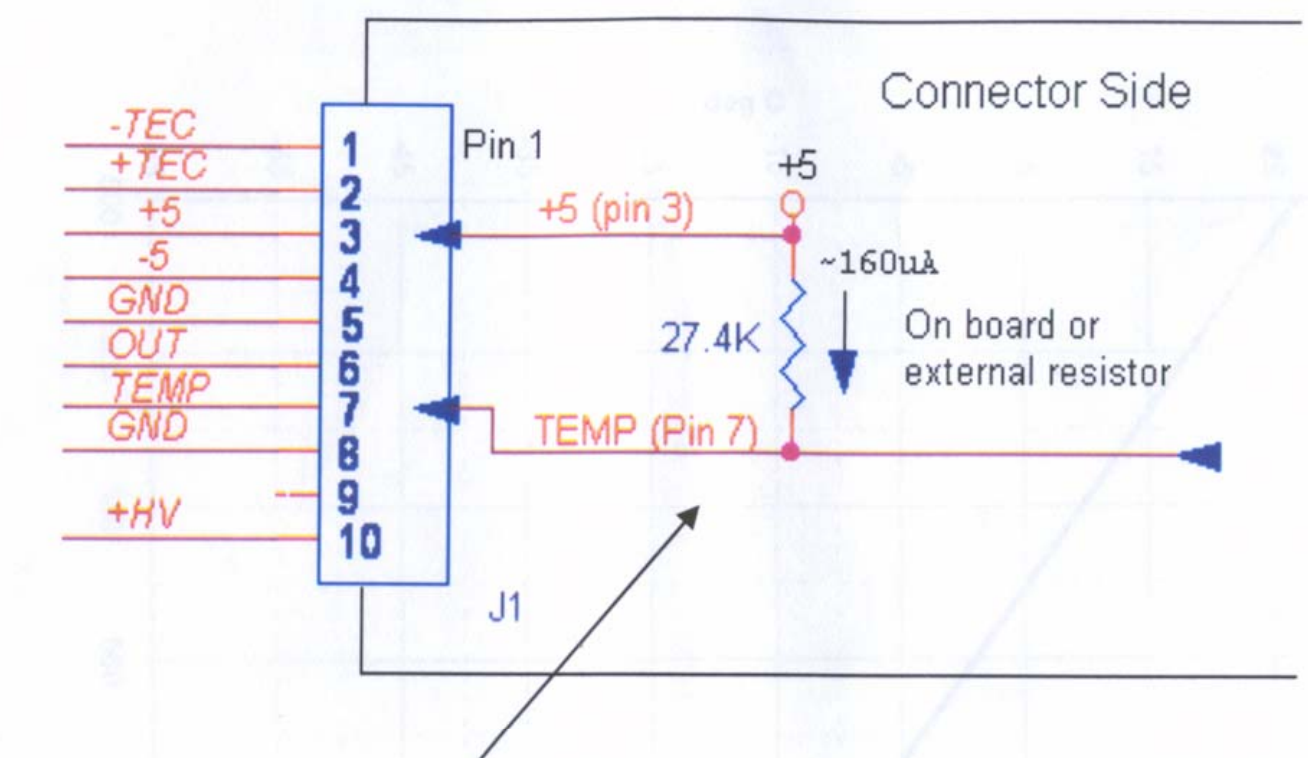

NOTE
 THE MATING CONNECTORS FOR THIS CABLE ASSEMBLY FACE IN OPPOSITE DIRECTIONS WHICH RESULTS IN A INVERSE MAPPING OF THE CONNECTOR NUMBERING. E.G. PIN1, A1A3J11 MAPS TO PIN 10 OF A1A2J1. THE ABOVE SCHEMATIC REFLECTS THIS MAPPING.

CONTRACT NO.		 APPLIED PHYSICS LABORATORY UNIVERSITY OF WASHINGTON SEATTLE WASHINGTON DETECTOR INTERFACE, CABLE ASSY A1W1, XRF HEAD, BOREHOLE XRF PROTOTYPE		
DRAWN BY LIGHT				
FILENAME BOREHOLE XRF PROTOTYPE CABLE ASSEMBLY DIAGRAMS REV1.14.VSD	SIZE B	CAGE CODE 98514	DWG NO XXXXXX	REV
DATE 23APR07	SHEET 1 OF 1			

4

3

2

1

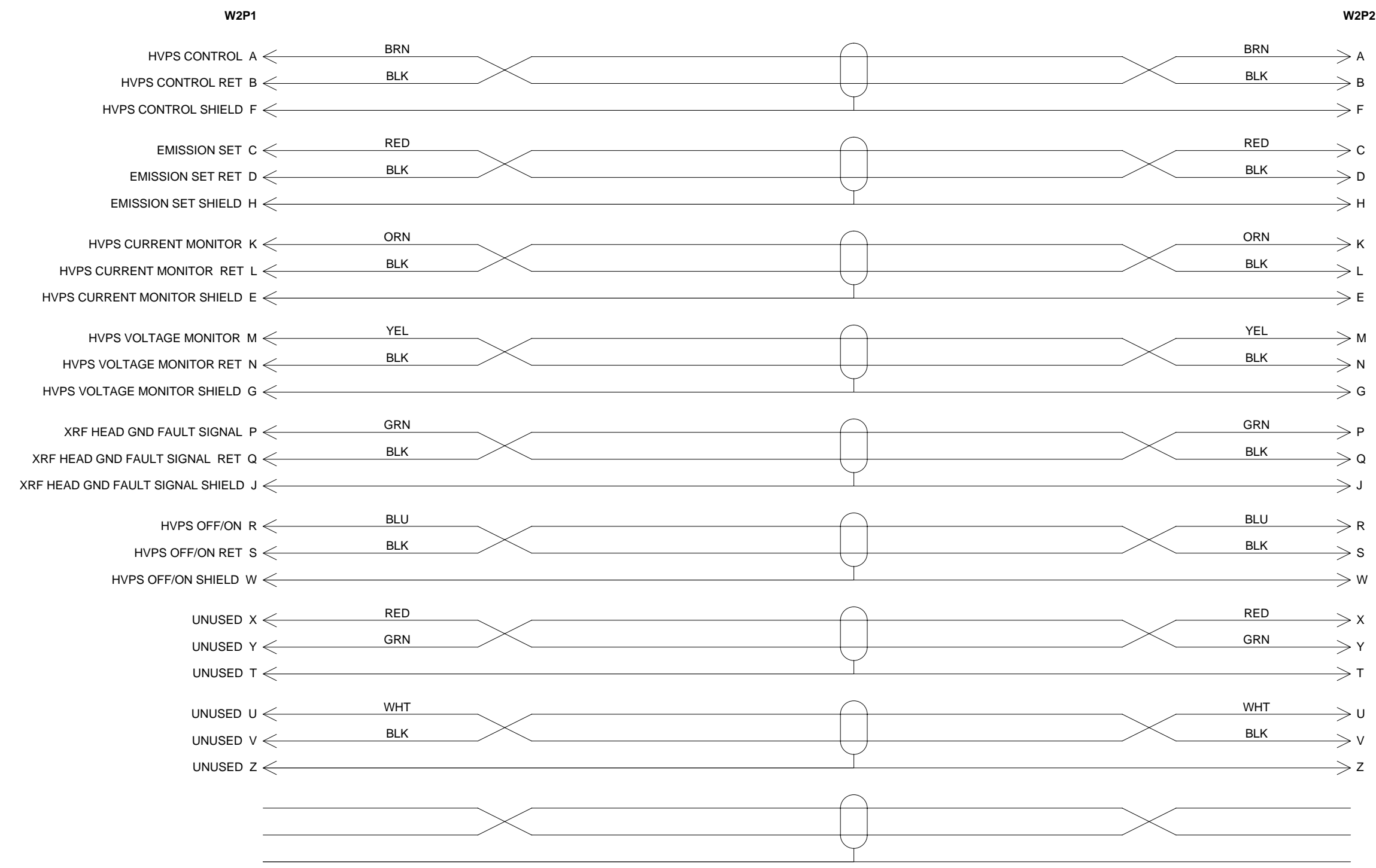

24 Contacts

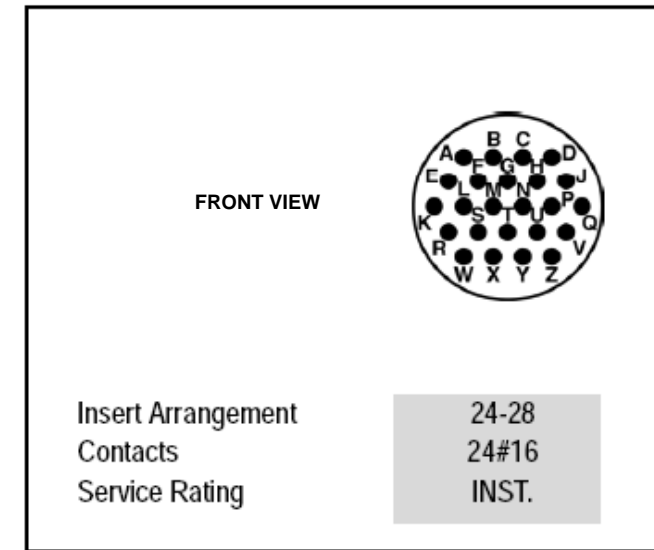

W2P1 (A2J1)

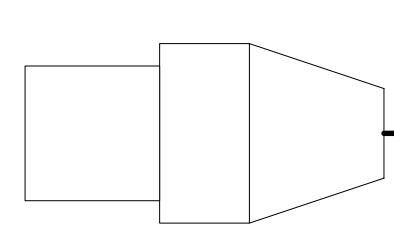

LABEL-APPLY USING LABEL WITH CLEAR HEAT SHRINK. W2P1 (A2J1)

AMPHENOL MIL-SPEC, PLUG, MALE 24 CONTACT 97-3106A-24-28P(417) WITH CLAMP 9767-28-10

BELDEN 8774

W2P2 (A3J1)

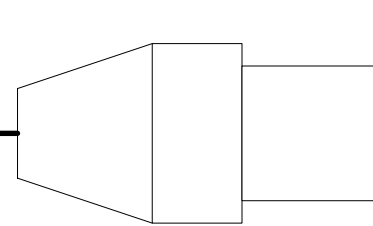

LABEL-APPLY USING LABEL WITH CLEAR HEAT SHRINK. W2P2 (A3J1)

AMPHENOL MIL-SPEC, PLUG, MALE 24 CONTACT 97-3106A-24-28P(417) WITH CLAMP 9767-28-10

CONTRACT NO.		 APPLIED PHYSICS LABORATORY UNIVERSITY OF WASHINGTON SEATTLE WASHINGTON	
DECKBOX INTERCONNECT-SIGNAL, CABLE ASSY A0W2, SYSTEM LEVEL, BOREHOLE XRF PROTOTYPE			
DRAWN BY	SIZE	CAGE CODE	DWG NO
LIGHT	D	98514	XXXXX
FILENAME	DATE	SHEET	REV
BOREHOLE XRF PROTOTYPE CABLE ASSEMBLY DIAGRAMS.REV14.VSD	21MAY07	1	7 OF 1

8

7

6

5

4

3

2

1

H

G

F

E

D

C

B

A

H

G

F

E

D

C

B

A

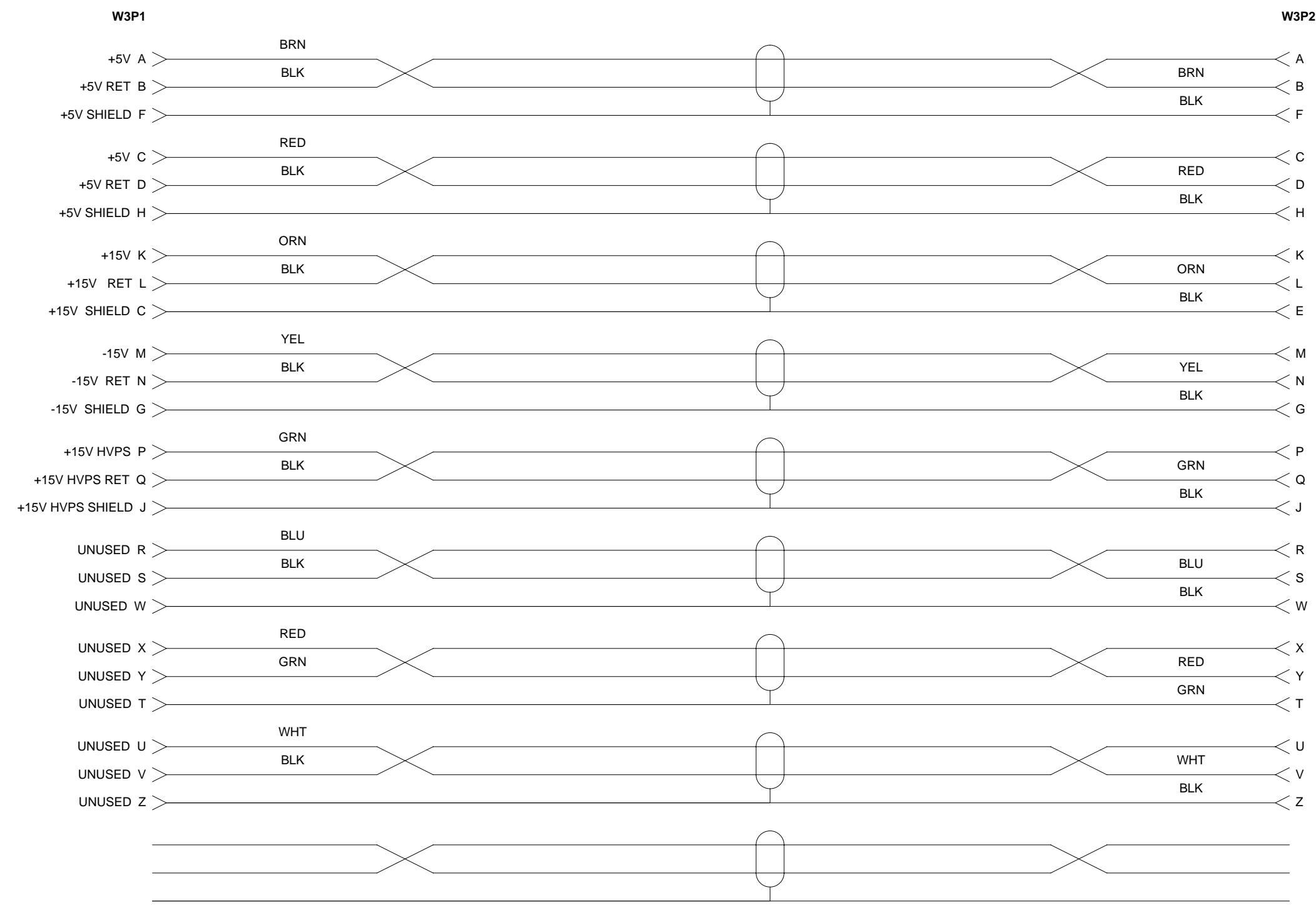

15 FEET

24 Contacts

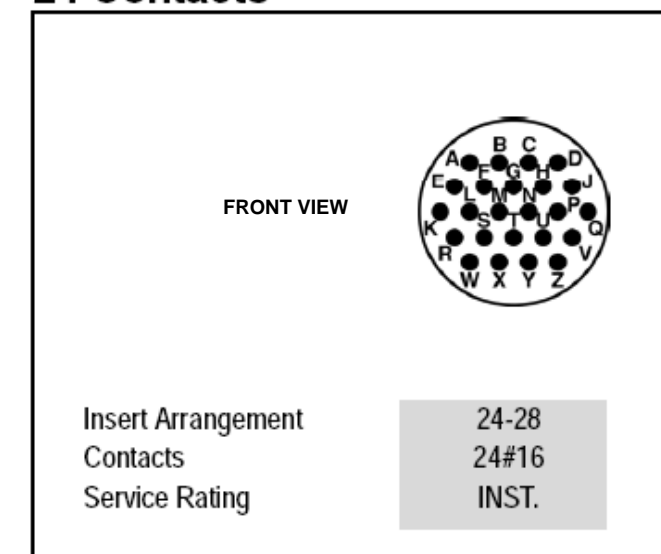

W3P1 (A2J2)

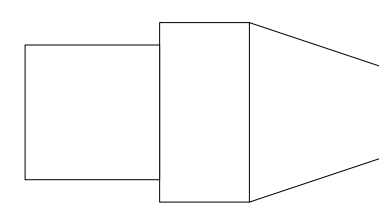

AMPHENOL MIL-SPEC, PLUG, FEMALE 24 CONTACT 97-3106A-28-28S(417) WITH CLAMP 9767-28-10

LABEL-APPLY USING LABEL WITH CLEAR HEAT SHRINK. W3P1 (A2J2)

BELDEN 8774

LABEL-APPLY USING LABEL WITH CLEAR HEAT SHRINK. W3P2 (A3J2)

W3P2 (A3J2)

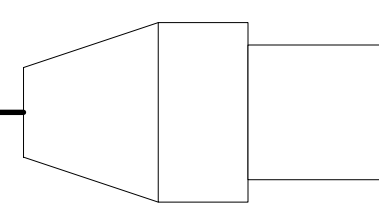

AMPHENOL MIL-SPEC, PLUG, FEMALE 24 CONTACT 97-3106A-28-28S(417) WITH CLAMP 9767-28-10

CONTRACT NO.		APPLIED PHYSICS LABORATORY UNIVERSITY OF WASHINGTON SEATTLE WASHINGTON	
DECKBOX INTERCONNECT-POWER, CABLE ASSY A0W3, SYSTEM LEVEL, BOREHOLE XRF PROTOTYPE			
DRAWN BY	SIZE	CAGE CODE	DWG NO
LIGHT	D	98514	XXXXX
FILENAME	DATE	SHEET	REV
BOREHOLE XRF PROTOTYPE CABLE ASSEMBLY DIAGRAMS.REV14.VSD	21MAY07	1	8 OF 1

8

7

6

5

4

3

2

1

4

3

2

1

D

D

C

C

B

B

A

A

A0W6P1
 SWITCH A >
 SWITCH RET B >
 N/C >
 CONNECT C >
 CONNECT RET D >

EXTERNAL
 INTERLOCK
 SWITCH
A5

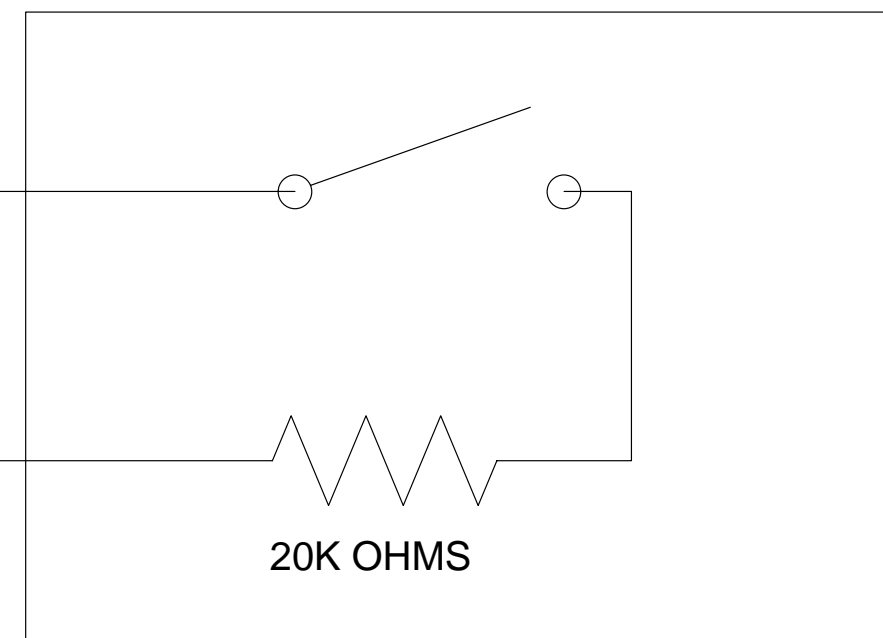

15 FEET

W6P1
 (A0A3J6)

LABEL-APPLY USING LABEL
 WITH CLEAR HEAT SHRINK.
W6P1
 (A0A3J6)

BELDEN 8412

EXTERNAL
 INTERLOCK
 SWITCH
A5

AMPHENOL
 MIL-SPEC, PLUG, FEMALE
 4 CONTACT
 97-3106A-14S-2S(417)
 9767-14-6

CONTRACT NO.		 APPLIED PHYSICS LABORATORY UNIVERSITY OF WASHINGTON SEATTLE WASHINGTON		
DRAWN BY LIGHT				EXTERNAL INTERLOCK SWITCH, CABLE ASSY A0W6, SYSTEM LEVEL, BOREHOLE XRF PROTOTYPE
FILENAME BOREHOLE XRF PROTOTYPE CABLE ASSEMBLY DIAGRAMS REV1.14.VSD	SIZE B	CAGE CODE 98514	DWG NO XXXXXX	REV
DATE 04MAY07	SHEET 1 OF 1			

4

3

2

1

4

3

2

1

D

D

A0W7P1

XRAY ACTIVE LAMP HOT A ←

XRAY ACTIVE LAMP RET B ←

N/C ←

XRAY ACTIVE LAMP CONNECT C ←

XRAY ACTIVE LAMP CONNECT D ←

XRAY ACTIVE LAMP
 12 WATTS, STEADY
 EDWARDS SIGNALING
 P/N 104SINHR-N5
A6

REPLACEMENT BULB
 FOR A6
 50LMP-12WH-D
 or industry trade no.
 15T7DC* (incandescent)

C

C

15 FEET

W7P1
(A0A3J7)

LABEL-APPLY USING LABEL
 WITH CLEAR HEAT SHRINK.
W7P1
(A0A3J7)

BELDEN 8412

MFG

XRAY ACTIVE LAMP
 12 WATTS, STEADY
 EDWARDS SIGNALING
 P/N 104SINHR-N5
A6

B

B

AMPHENOL
 MIL-SPEC, PLUG, MALE
 4 CONTACT
 97-3106A-14S-2P(417)
 9767-14-6

SPLICE TO MFG WIRE, APPLY HEATSHRINK

A

A

CONTRACT NO.		 APPLIED PHYSICS LABORATORY UNIVERSITY OF WASHINGTON SEATTLE WASHINGTON		
DRAWN BY LIGHT				
FILENAME BOREHOLE XRF PROTOTYPE CABLE ASSEMBLY DIAGRAMS REV1.14.VSD	SIZE B	CAGE CODE 98514	DWG NO XXXXXX	REV
DATE 04MAY07	SHEET		1 OF 1	

4

3

2

1

4

3

2

1

D

D

A0W8P1

A0W8P2



C

C

50 FEET

W8P1
(A0A3J5)

LABEL-APPLY USING LABEL
WITH CLEAR HEAT SHRINK.
W8P1
(A0A3J5)

A0W8P2
(AC POWER SOURCE)

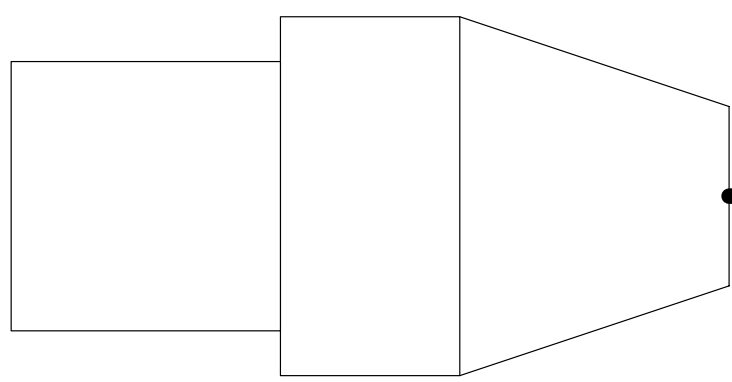

AMPHENOL
MIL-SPEC, PLUG, FEMALE
3 CONTACT
97-3106A-16-10S(417)
9767-16-6

GENERIC AC POWER CORD

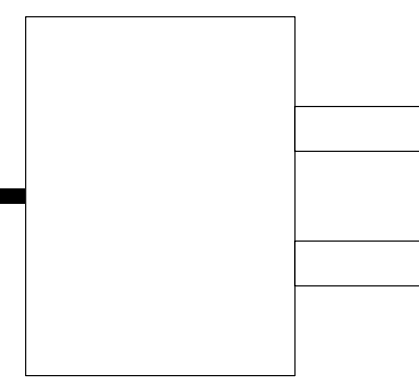

AC POWER PLUG
3-PRONG
MOLDED TO CABLE
GENERIC

B

B

A

A

CONTRACT NO.		 APPLIED PHYSICS LABORATORY UNIVERSITY OF WASHINGTON SEATTLE WASHINGTON		
DRAWN BY LIGHT				
FILENAME BOREHOLE XRF PROTOTYPE CABLE ASSEMBLY DIAGRAMS REV1.14.VSD	SIZE B	CAGE CODE 98514	DWG NO XXXXXX	REV
DATE 23MAY07	SHEET		1 OF 1	

4

3

2

1

4

3

2

1

D

D

C

C

B

B

A

A

HIGH VOLTAGE +
CONNECTOR
ULTRAVOLT
B110US10/CA-40KV-1002
J4
(A0W1P1)

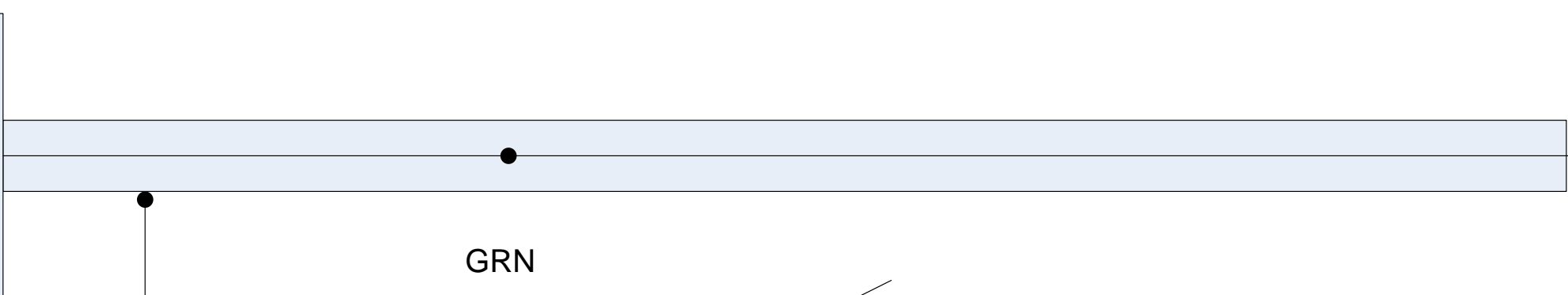

HIGH VOLTAGE MODULE 40A12-N4
MOUNTED ON A0A2A1

HIGH VOLTAGE +
CONNECTOR
ULTRAVOLT
B110US10/CA-40KV-1002
J4
(A0W1P1)

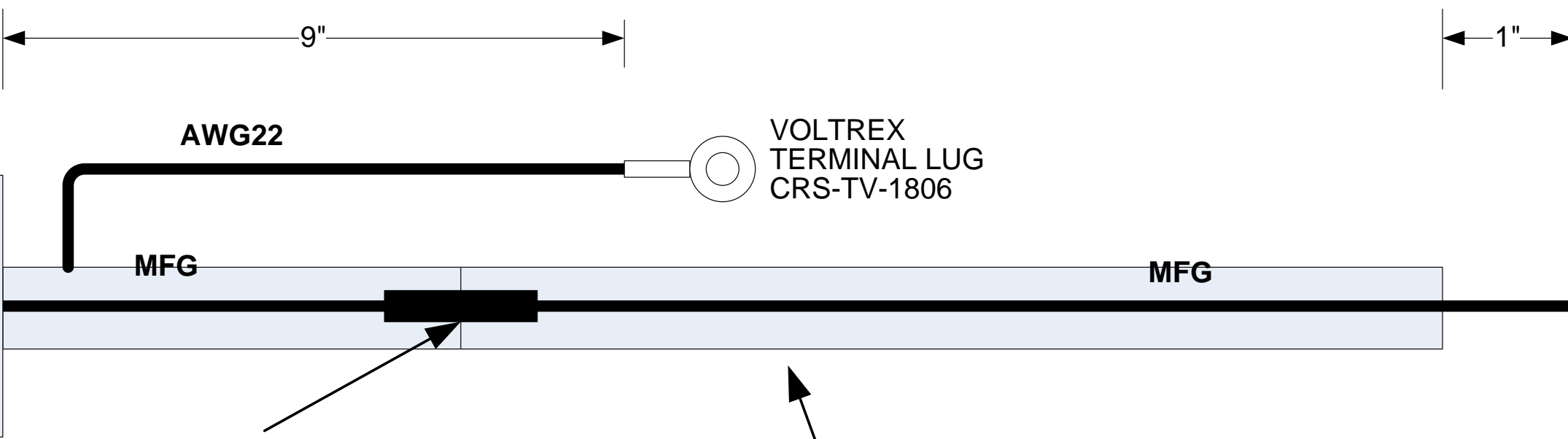

HIGH VOLTAGE MODULE 40A12-N4
MOUNTED ON A0A2A1

1. SEE NOTE BELOW FOR SPLICING
INFORMATION
2. SHIELD SOLDERED AT SPLICE.

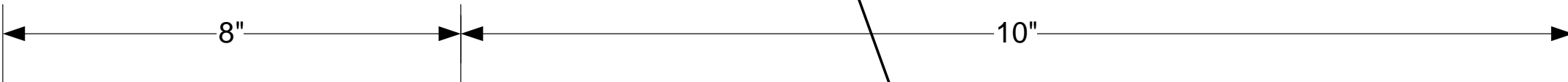

2 PIECES OF SHIELD BELDEN 92171
COVERED WITH NYLON BRAID COVERING
SOLDERED AT THE MIDDLE OF THE
POLYCARBONATE TUBE.

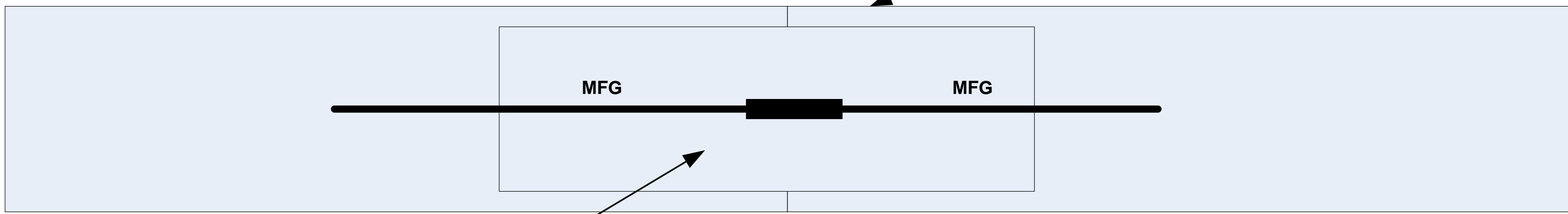
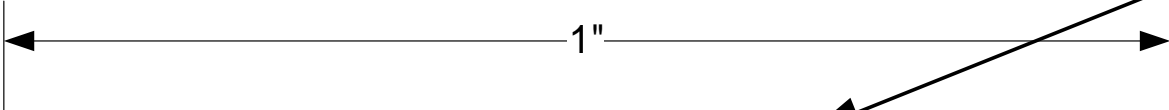

POLYCARBONATE ROD VOIDS FILLED
WITH 5 MINUTE EPOXY

NOTE:
1. POLYCARBONATE ROD DRILLED OUT TO
DIAMETER OF THE HIGH VOLTAGE WIRE.
2. SPLICE THE TWO WIRES TOGETHER.
3. FILL VOIDS WITH 5 MINUTE EPOXY.
4. PUT 2 PIECES OF SHIELD BELDEN P/N
92171 OVER HIGH VOLTAGE WIRE.
SOLDERED BRAID AT THE SPLICE. TIE BRAID
AND NYLON COVERING WITH HEAT SCRINK.
5. TIE SHIELD TO CHASSIS.

CONTRACT NO.		 APPLIED PHYSICS LABORATORY UNIVERSITY OF WASHINGTON SEATTLE WASHINGTON HIGH VOLTAGE WIRE, CABLE ASSEMBLY A2W2, XRF CONTROL UNIT A0A2, BOREHOLE XRAY PROTOTYPE		
DRAWN BY SABIN				
FILENAME BOREHOLE XRF PROTOTYPE CABLE ASSEMBLY DIAGRAMS REV1.14.VSD	SIZE B	CAGE CODE 98514	DWG NO XXXXXX	REV
DATE 4JUNE2007	SHEET 1 OF 1			

4

3

2

1

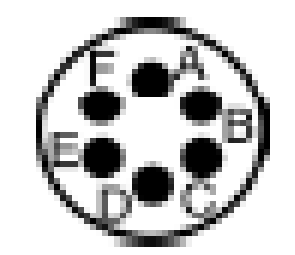
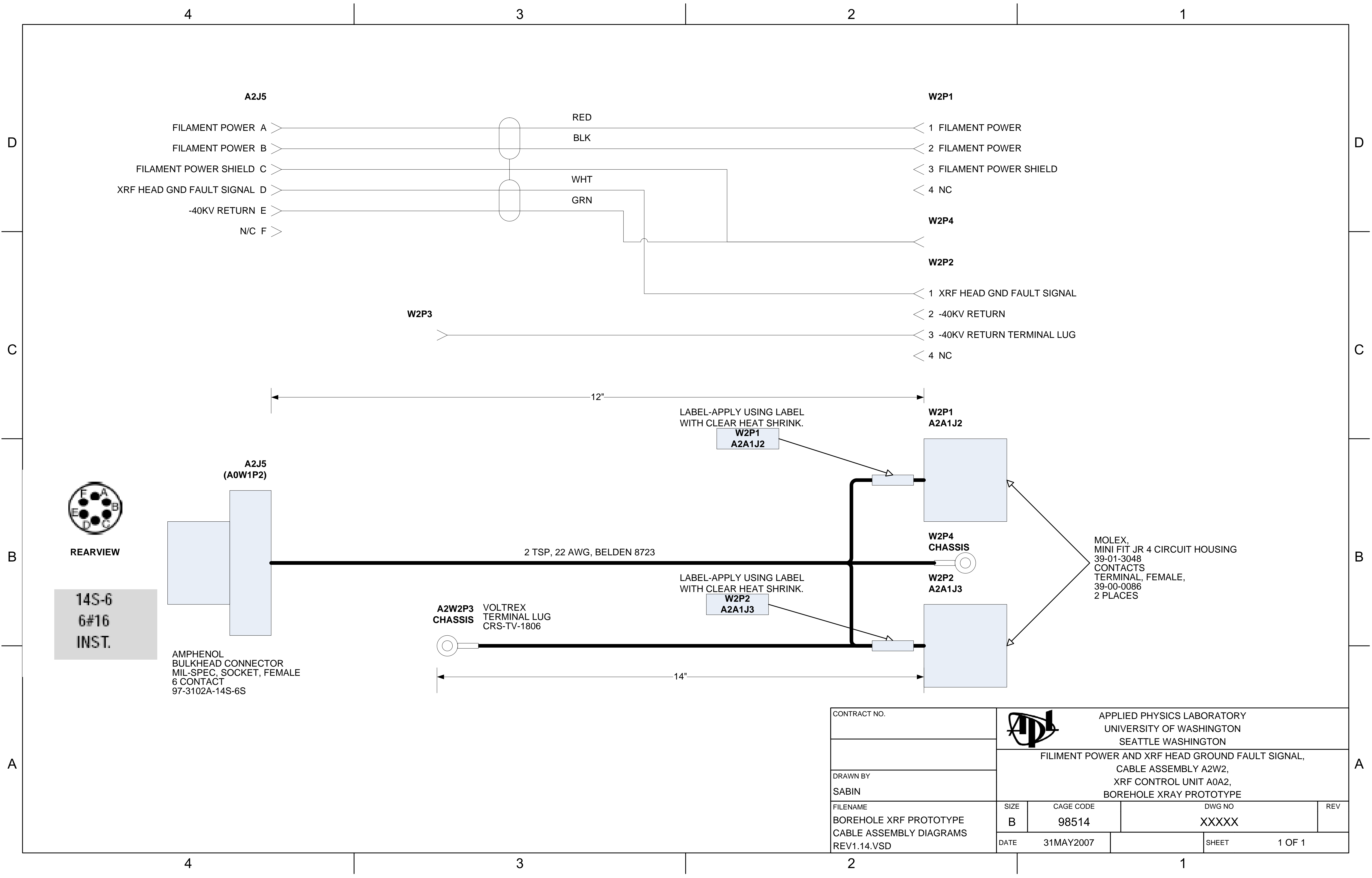

REARVIEW

14S-6
6#16
INST.

AMPHENOL
BULKHEAD CONNECTOR
MIL-SPEC, SOCKET, FEMALE
6 CONTACT
97-3102A-14S-6S

A2W2P3 VOLTREX
CHASSIS TERMINAL LUG
CRS-TV-1806

LABEL-APPLY USING LABEL
WITH CLEAR HEAT SHRINK.
W2P1
A2A1J2

LABEL-APPLY USING LABEL
WITH CLEAR HEAT SHRINK.
W2P2
A2A1J3

MOLEX,
MINI FIT JR 4 CIRCUIT HOUSING
39-01-3048
CONTACTS
TERMINAL, FEMALE,
39-00-0086
2 PLACES

CONTRACT NO.		 APPLIED PHYSICS LABORATORY UNIVERSITY OF WASHINGTON SEATTLE WASHINGTON		
DRAWN BY SABIN		FILIMENT POWER AND XRF HEAD GROUND FAULT SIGNAL, CABLE ASSEMBLY A2W2, XRF CONTROL UNIT A0A2, BOREHOLE XRAY PROTOTYPE		
FILENAME BOREHOLE XRF PROTOTYPE CABLE ASSEMBLY DIAGRAMS REV1.14.VSD	SIZE B	CAGE CODE 98514	DWG NO XXXXXX	REV
DATE 31MAY2007	SHEET 1 OF 1			

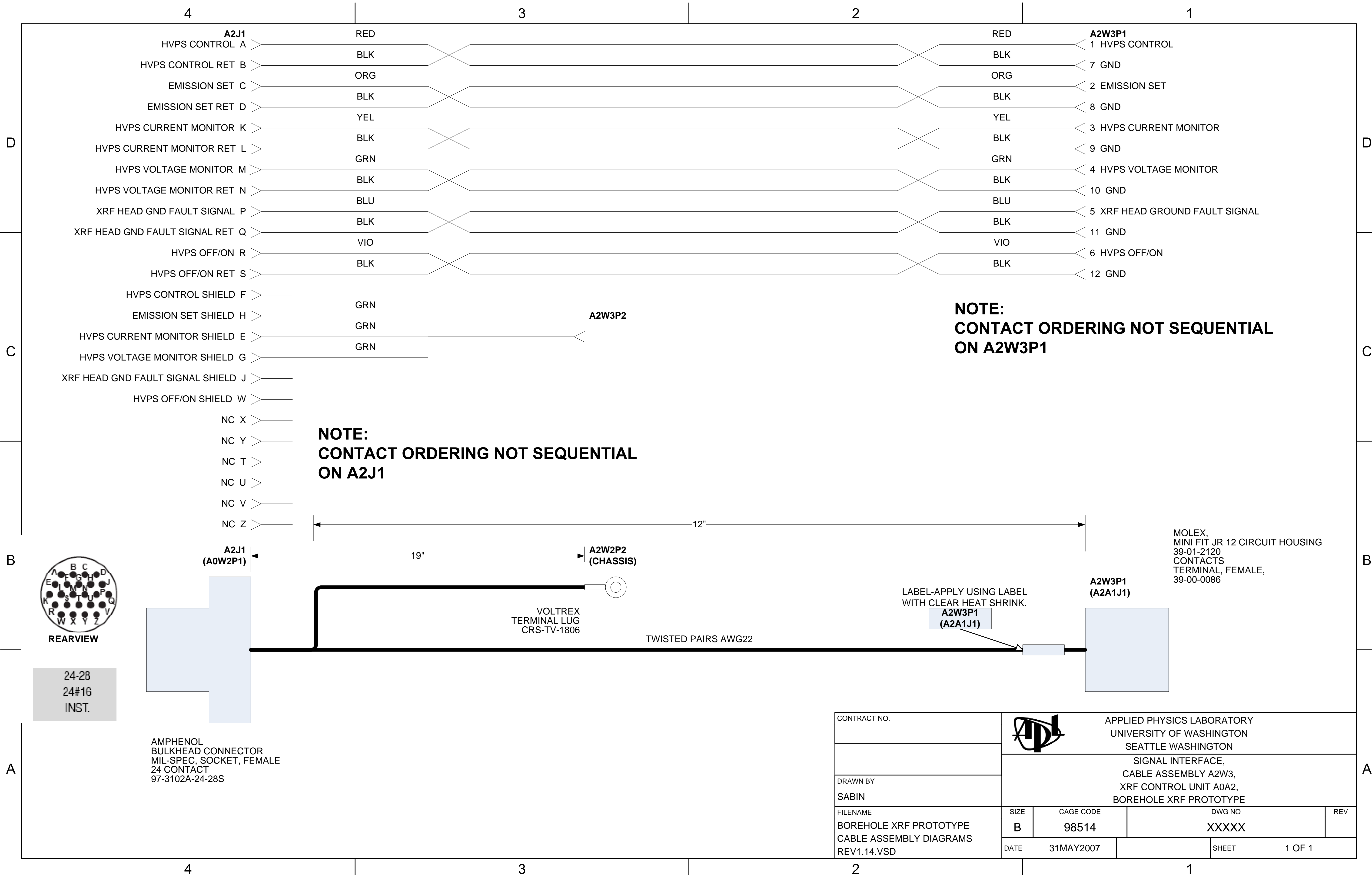

CONTRACT NO.		 APPLIED PHYSICS LABORATORY UNIVERSITY OF WASHINGTON SEATTLE WASHINGTON			
DRAWN BY SABIN					
FILENAME BOREHOLE XRF PROTOTYPE CABLE ASSEMBLY DIAGRAMS REV1.14.VSD		SIZE B	CAGE CODE 98514	DWG NO XXXXXX	REV
DATE 31MAY2007		SHEET 1 OF 1			

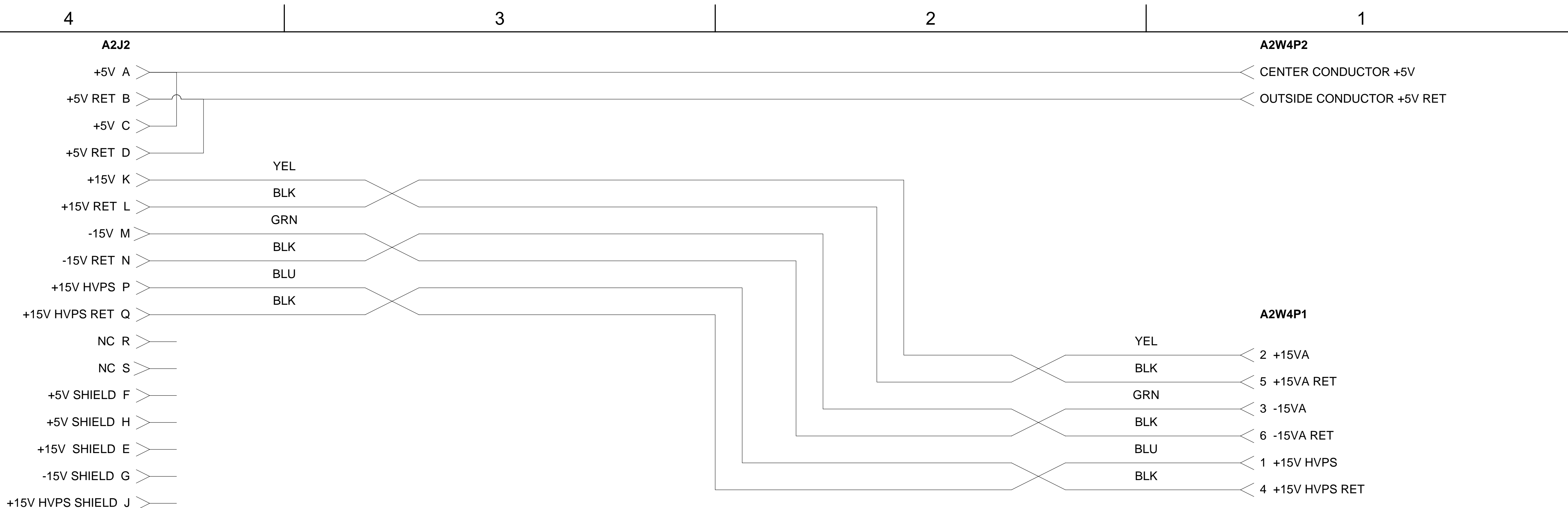

**NOTE:
CONTACT ORDERING NOT SEQUENTIAL
ON A2J2**

**NOTE:
CONTACT ORDERING NOT SEQUENTIAL
ON A2W4P1**

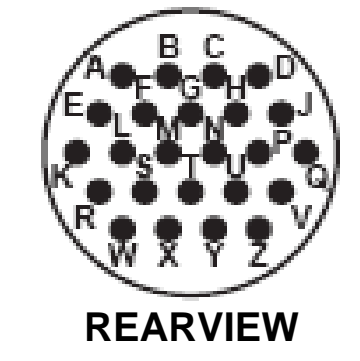
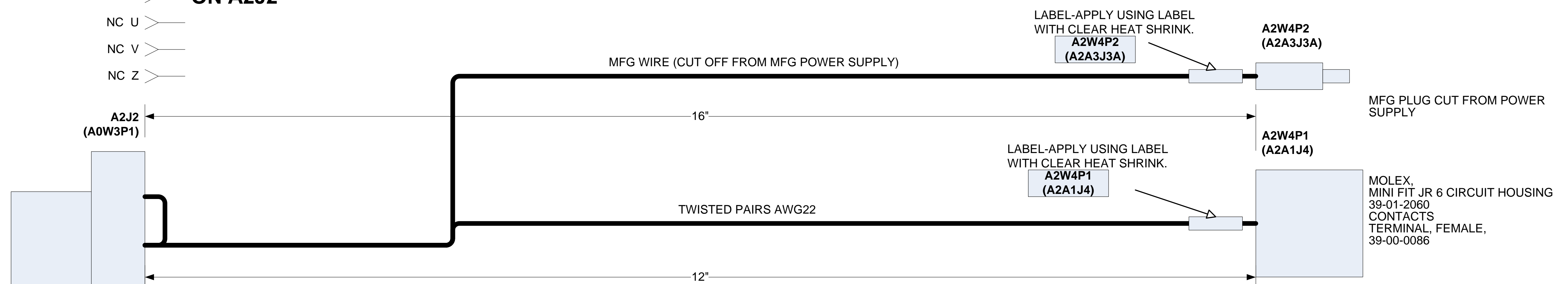

24-28
24#16
INST.

AMPHENOL
BULKHEAD CONNECTOR
MIL-SPEC, JACK, MALE
24 CONTACT
97-3102A-24-28P

CONTRACT NO.		 APPLIED PHYSICS LABORATORY UNIVERSITY OF WASHINGTON SEATTLE WASHINGTON			
DRAWN BY SABIN					
FILENAME BOREHOLE XRF PROTOTYPE CABLE ASSEMBLY DIAGRAMS REV1.14.VSD		SIZE B	CAGE CODE 98514	DWG NO XXXXXX	REV
DATE 31MAY2007		SHEET 1 OF 1			

4 | 3 | 2 | 1

D

D

C

C

B

B

A

A

4 | 3 | 2 | 1

4

3

2

1

D

D

C

C

B

B

A

A



**NOTE:
CONTACT
ORDERING NOT
SEQUENTIAL**

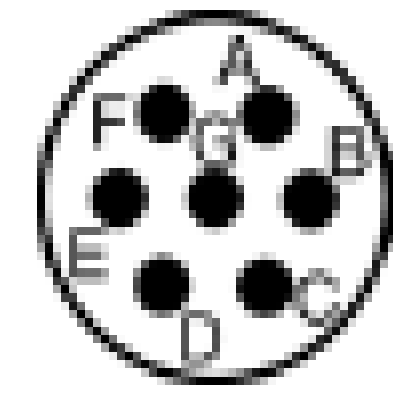
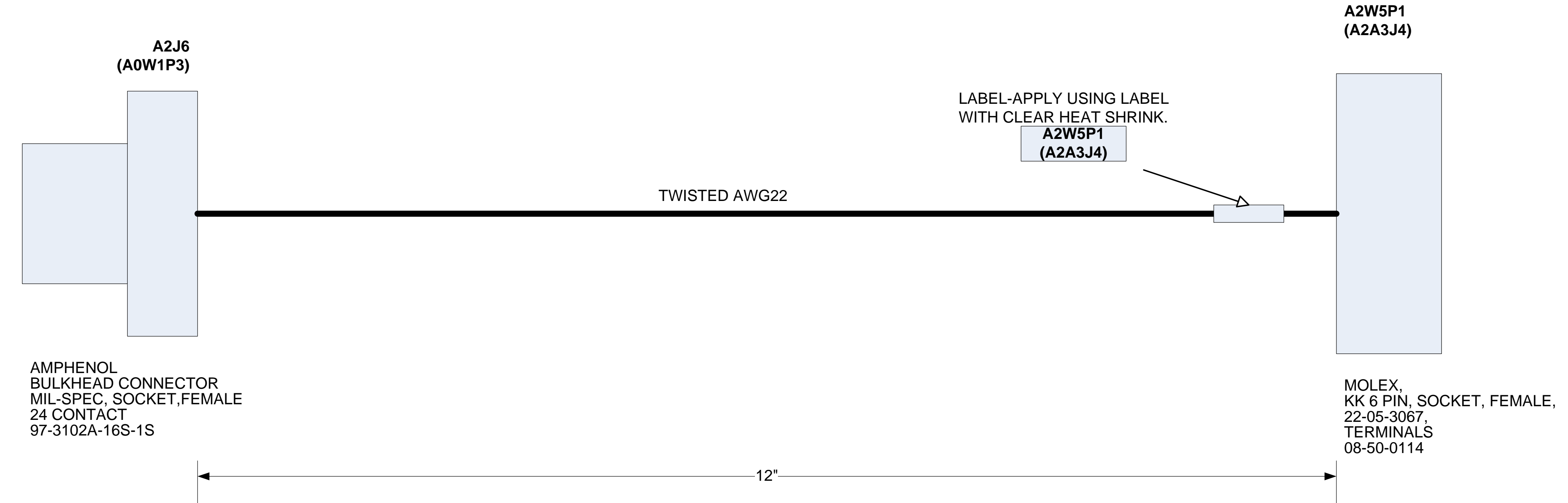

REARVIEW

16S-1
7#16
A

CONTRACT NO.		 APPLIED PHYSICS LABORATORY UNIVERSITY OF WASHINGTON SEATTLE WASHINGTON DETECTOR POWER, CABLE ASSEMBLY A2W5, XRF CONTROL UNIT A0A2, BOREHOLE XRF PROTOTYPE		
DRAWN BY SABIN				
FILENAME BOREHOLE XRF PROTOTYPE CABLE ASSEMBLY DIAGRAMS REV1.14.VSD	SIZE B	CAGE CODE 98514	DWG NO XXXXXX	REV
DATE 31MAY2007	SHEET 1 OF 1			

4

3

2

1

4 3 2 1

D

D

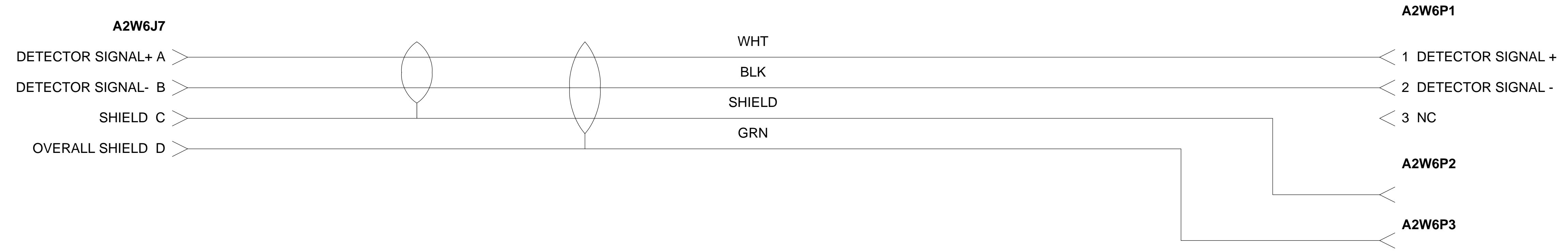

C

C

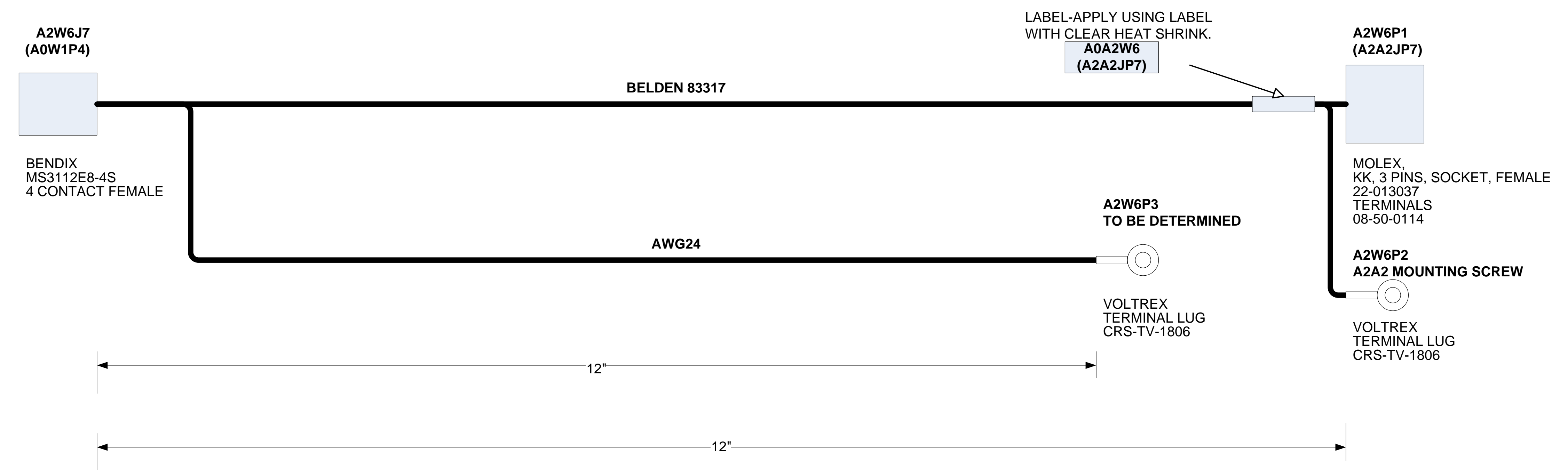

B

B

A

A

CONTRACT NO.		 APPLIED PHYSICS LABORATORY UNIVERSITY OF WASHINGTON SEATTLE WASHINGTON			
DRAWN BY SABIN					
FILENAME BOREHOLE XRF PROTOTYPE CABLE ASSEMBLY DIAGRAMS REV1.14.VSD		SIZE B	CAGE CODE 98514	DWG NO XXXXXX	REV
DATE 22AUG2007		SHEET 1 OF 1			

4 3 2 1

4

3

2

1

A2W7P1

A2W7P2



A2W7P1
(A2A2JP6)

MFG WIRE

A2W7P2
A2A3J1)

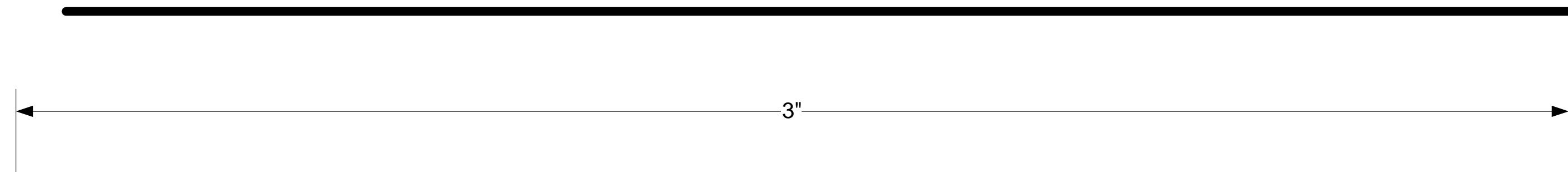

NOTE: NO CONNECTOR IS USED.
CONNECTOR IS PART OF FLEX
CABLE.

D

D

C

C

B

B

A

A

CONTRACT NO.		 APPLIED PHYSICS LABORATORY UNIVERSITY OF WASHINGTON SEATTLE WASHINGTON		
DRAWN BY SABIN				
FILENAME BOREHOLE XRF PROTOTYPE CABLE ASSEMBLY DIAGRAMS REV1.14.VSD	SIZE B	CAGE CODE 98514	DWG NO XXXXXX	REV
DATE 31MAY2007	SHEET		1 OF 1	

4

3

2

1

4

3

2

1

D

D

C

C

B

B

A

A



**NOTE:
CONTACT ORDERING NOT SEQUENTIAL
ON A6**

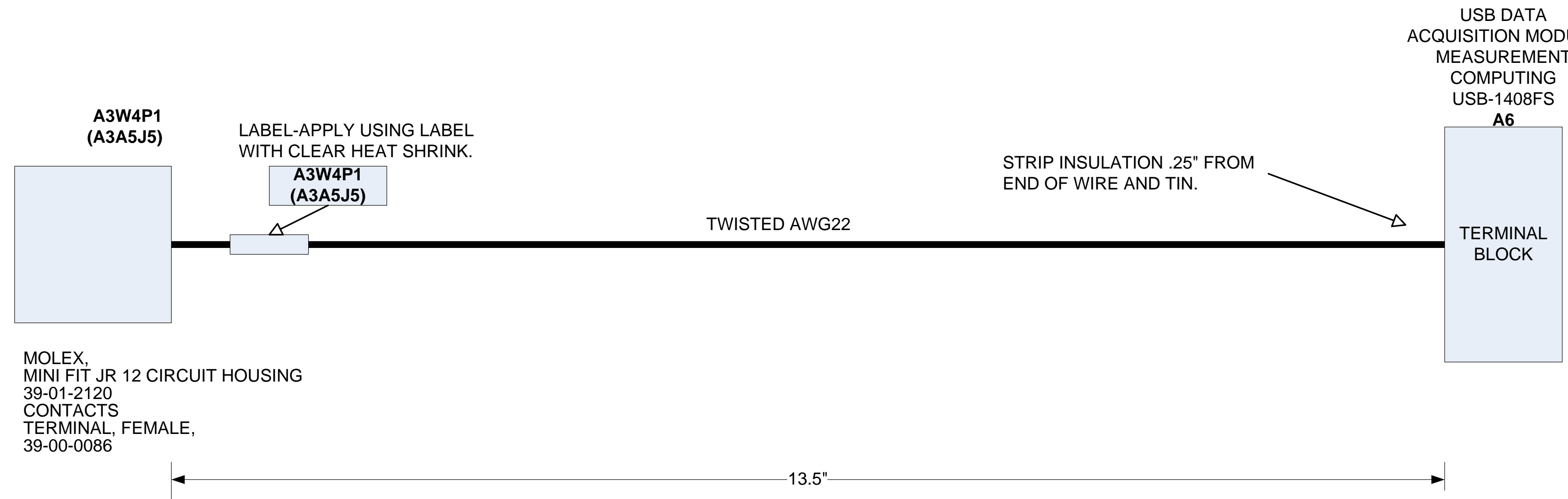

MOLEX,
MINI FIT JR 12 CIRCUIT HOUSING
39-01-2120
CONTACTS
TERMINAL, FEMALE,
39-00-0086

CONTRACT NO.		 APPLIED PHYSICS LABORATORY UNIVERSITY OF WASHINGTON SEATTLE WASHINGTON DIGITAL SIGNAL INTERFACE TO USB-1408FS, CABLE ASSEMBLY A3W4, XRF INTERFACE UNIT A0A3, BOREHOLE XRF PROTOTYPE		
DRAWN BY SABIN				
FILENAME BOREHOLE XRF PROTOTYPE CABLE ASSEMBLY DIAGRAMS REV1.14.VSD	SIZE B	CAGE CODE 98514	DWG NO XXXXXX	REV
DATE 31MAY2007	SHEET 1 OF 1			

4

3

2

1

4

3

2

1

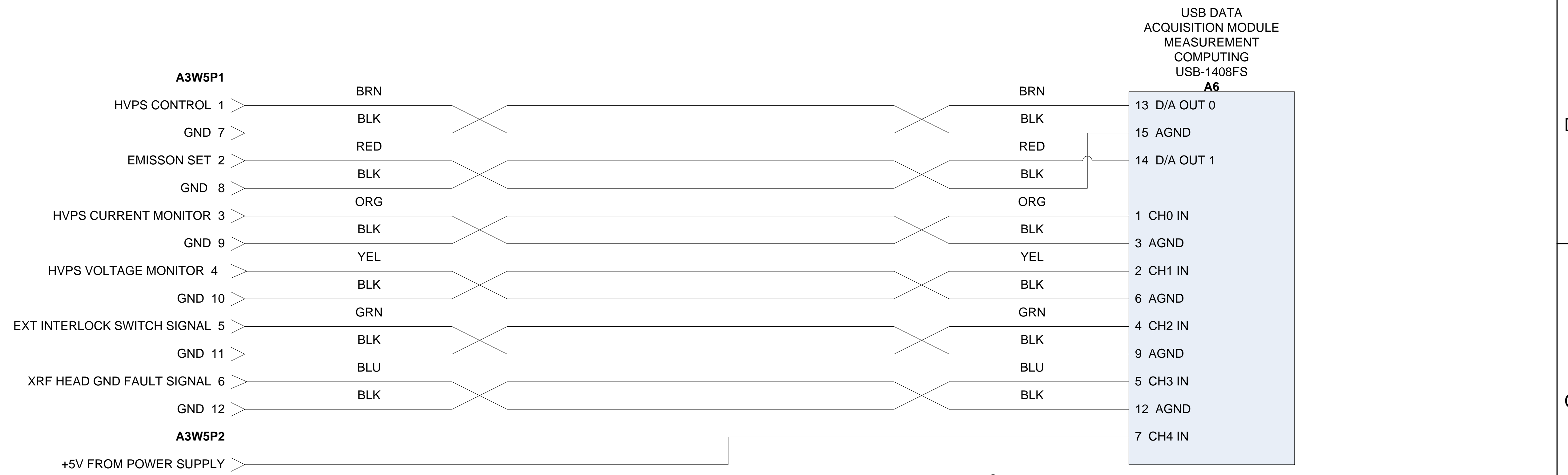

**NOTE:
CONTACT ORDERING NOT SEQUENTIAL
ON A3W5P1**

**NOTE:
CONTACT ORDERING NOT SEQUENTIAL
ON A6**

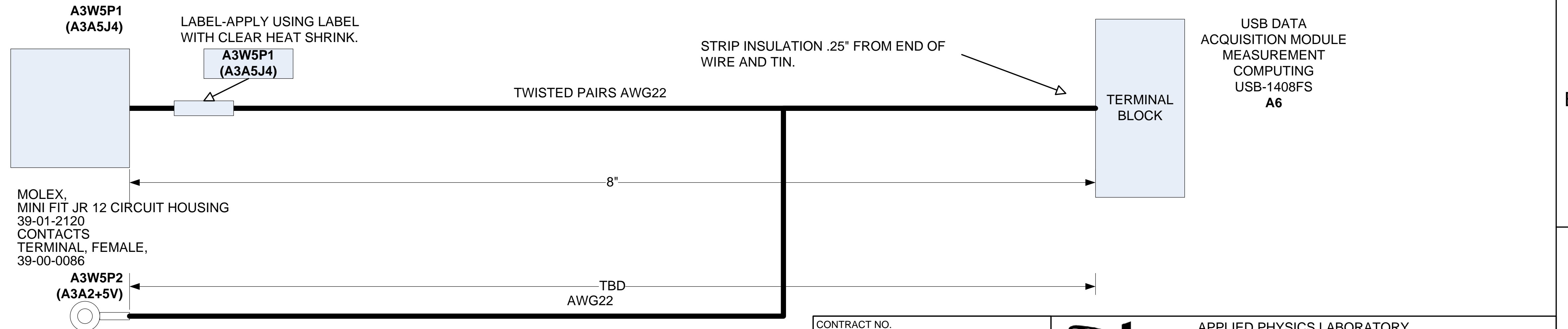

MOLEX,
MINI FIT JR 12 CIRCUIT HOUSING
39-01-2120
CONTACTS
TERMINAL, FEMALE,
39-00-0086

A3W5P2
(A3A2+5V)

VOLTREX
TERMINAL LUG
CRS-TV-1806

CONTRACT NO.		 APPLIED PHYSICS LABORATORY UNIVERSITY OF WASHINGTON SEATTLE WASHINGTON		
DRAWN BY SABIN				
FILENAME BOREHOLE XRF PROTOTYPE CABLE ASSEMBLY DIAGRAMS REV1.14.VSD	SIZE B	CAGE CODE 98514	DWG NO XXXXXX	REV
DATE 8JUNE2007	SHEET 1 OF 1			

4

3

2

1

D

D

C

C

B

B

A

A

4

3

2

1

D

D

C

C

B

B

A

A

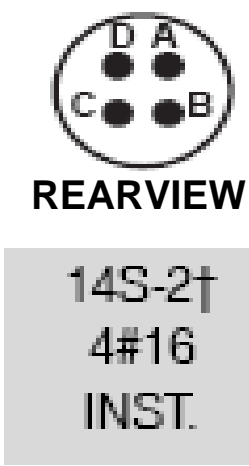
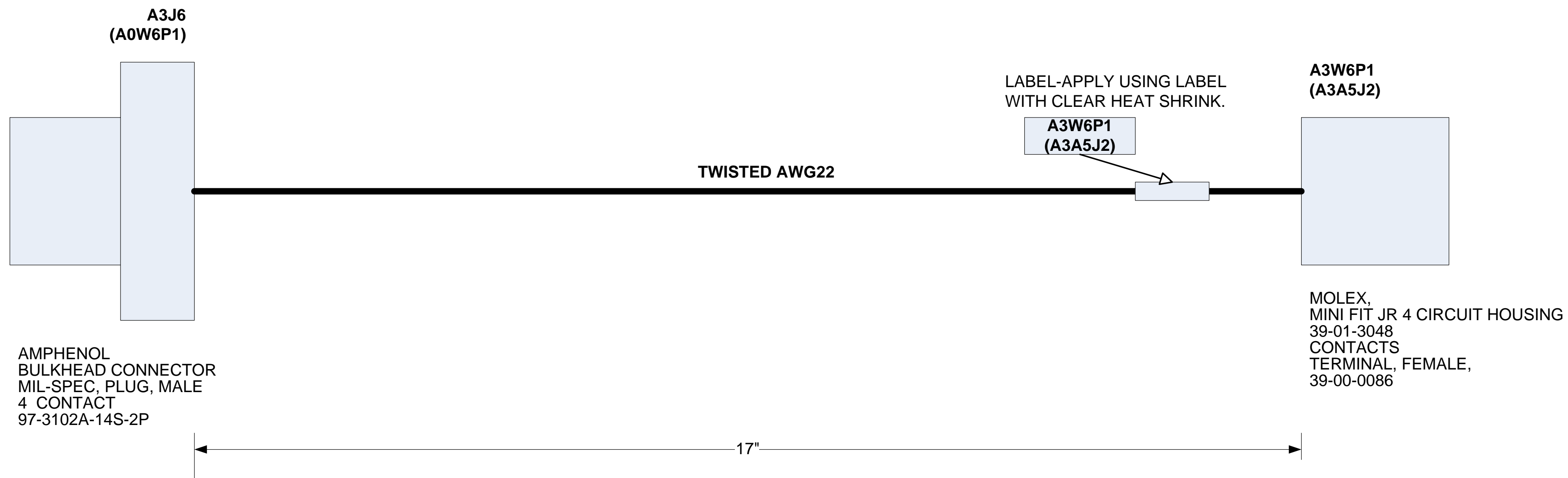

AMPHENOL
BULKHEAD CONNECTOR
MIL-SPEC, PLUG, MALE
4 CONTACT
97-3102A-14S-2P

MOLEX,
MINI FIT JR 4 CIRCUIT HOUSING
39-01-3048
CONTACTS
TERMINAL, FEMALE,
39-00-0086

CONTRACT NO.		 APPLIED PHYSICS LABORATORY UNIVERSITY OF WASHINGTON SEATTLE WASHINGTON EXTERNAL INTERLOCK SWITCH, CABLE ASSEMBLY A3W6 XRF INTERFACE UNIT A0A3, BOREHOLE XRF PROTOTYPE		
DRAWN BY SABIN				
FILENAME BOREHOLE XRF PROTOTYPE CABLE ASSEMBLY DIAGRAMS REV1.14.VSD	SIZE B	CAGE CODE 98514	DWG NO XXXXXX	REV
DATE 31MAY2007	SHEET 1 OF 1			

4

3

2

1

4

3

2

1

D

D

A3W7P2

+5V

A3W7P3

+5V RET

A3W7P1

CENTER CONDUCTOR +5V

OUTSIDE CONDUCTOR +5V RET

C

C

B

B

A

A

A3W7P2
(TB2+5V)

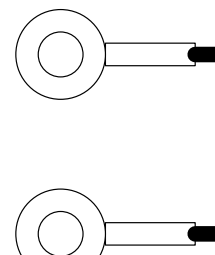

A3W7P3
(TB2+5VRET)
VOLTREX
TERMINAL LUG
CRS-TV-1806

MFG WIRE FROM MFG POWER SUPPLY

LABEL-APPLY USING LABEL
WITH CLEAR HEAT SHRINK.

A3W7P1
(A3A1PWR)

A3W7P1
(A3A1PWR)

PLUG FROM MFG POWER
SUPPLY

14"

CONTRACT NO.		 APPLIED PHYSICS LABORATORY UNIVERSITY OF WASHINGTON SEATTLE WASHINGTON USB HUB POWER, CABLE ASSEMBLY A3W7 XRF INTERFACE UNIT A0A3, BOREHOLE XRF PROTOTYPE		
DRAWN BY SABIN				
FILENAME BOREHOLE XRF PROTOTYPE CABLE ASSEMBLY DIAGRAMS REV1.14.VSD	SIZE B	CAGE CODE 98514	DWG NO XXXXXX	REV
DATE 31MAY2007	SHEET		1 OF 1	

4

3

2

1

4

3

2

1

D

D

C

C

B

B

A

A

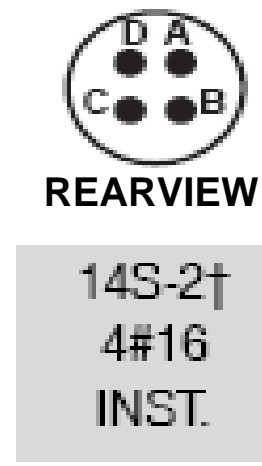
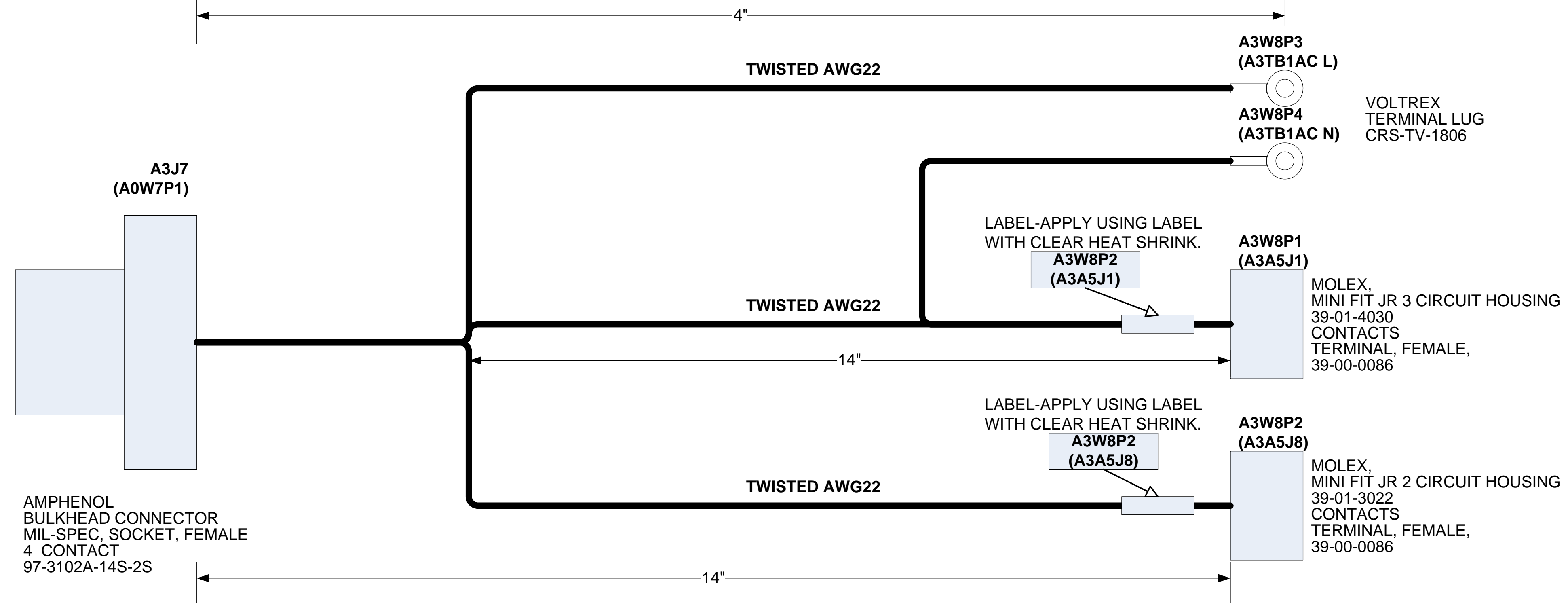
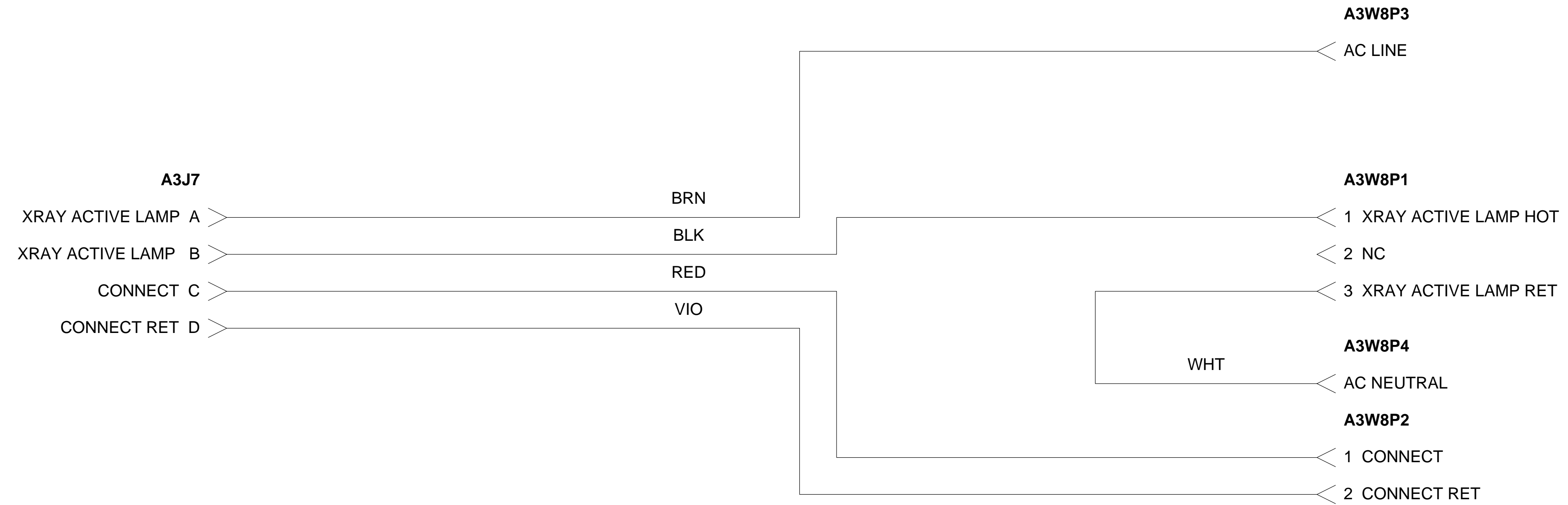

AMPHENOL
BULKHEAD CONNECTOR
MIL-SPEC, SOCKET, FEMALE
4 CONTACT
97-3102A-14S-2S

14S-2†
4#16
INST.

CONTRACT NO.		 APPLIED PHYSICS LABORATORY UNIVERSITY OF WASHINGTON SEATTLE WASHINGTON USB HUB POWER, CABLE ASSEMBLY A3W8 XRF INTERFACE UNIT A0A3, BOREHOLE XRF PROTOTYPE		
DRAWN BY SABIN				
FILENAME BOREHOLE XRF PROTOTYPE CABLE ASSEMBLY DIAGRAMS REV1.14.VSD	SIZE B	CAGE CODE 98514	DWG NO XXXXXX	REV
DATE 31MAY2007	SHEET 1 OF 1			

4

3

2

1

4

3

2

1

D

D

C

C

B

B

A

A

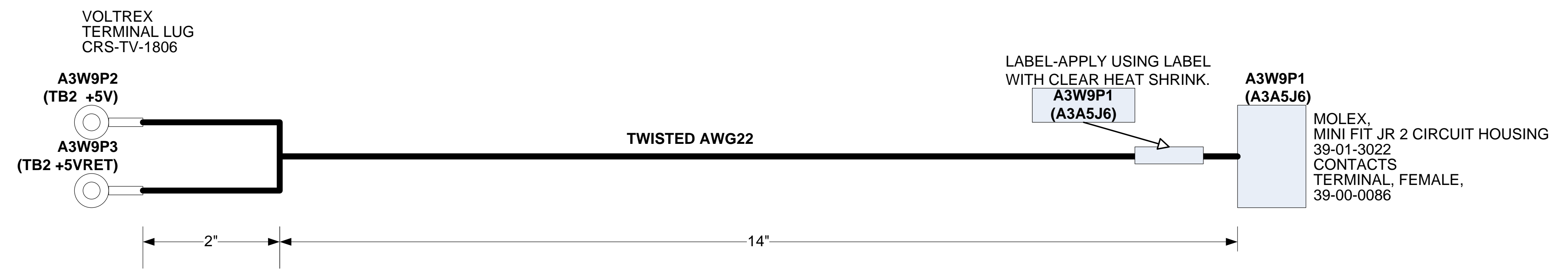
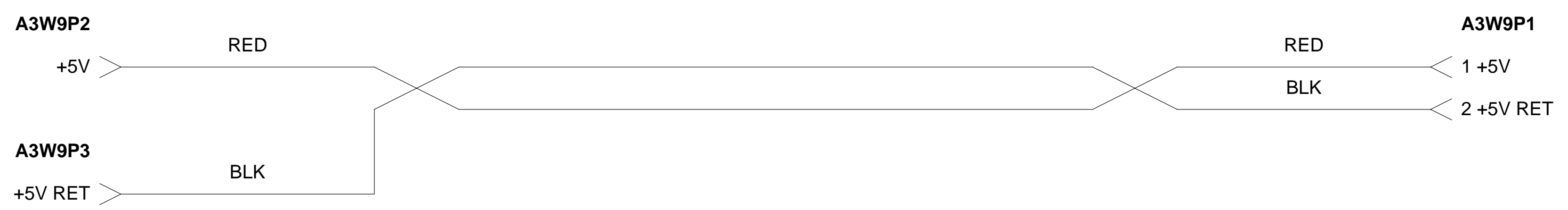

CONTRACT NO.		 APPLIED PHYSICS LABORATORY UNIVERSITY OF WASHINGTON SEATTLE WASHINGTON			
DRAWN BY SABIN					
FILENAME BOREHOLE XRF PROTOTYPE CABLE ASSEMBLY DIAGRAMS REV1.14.VSD		SIZE B	CAGE CODE 98514	DWG NO XXXXXX	REV
DATE 31MAY2007		SHEET 1 OF 1			

4

3

2

1

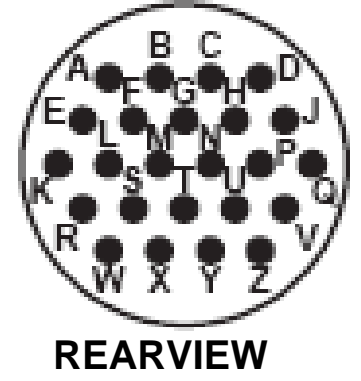
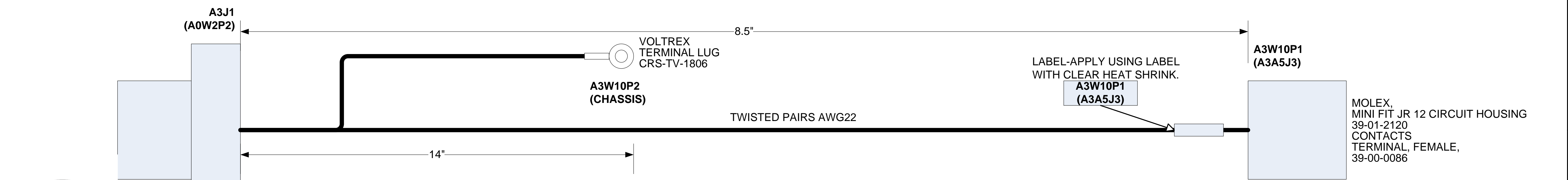
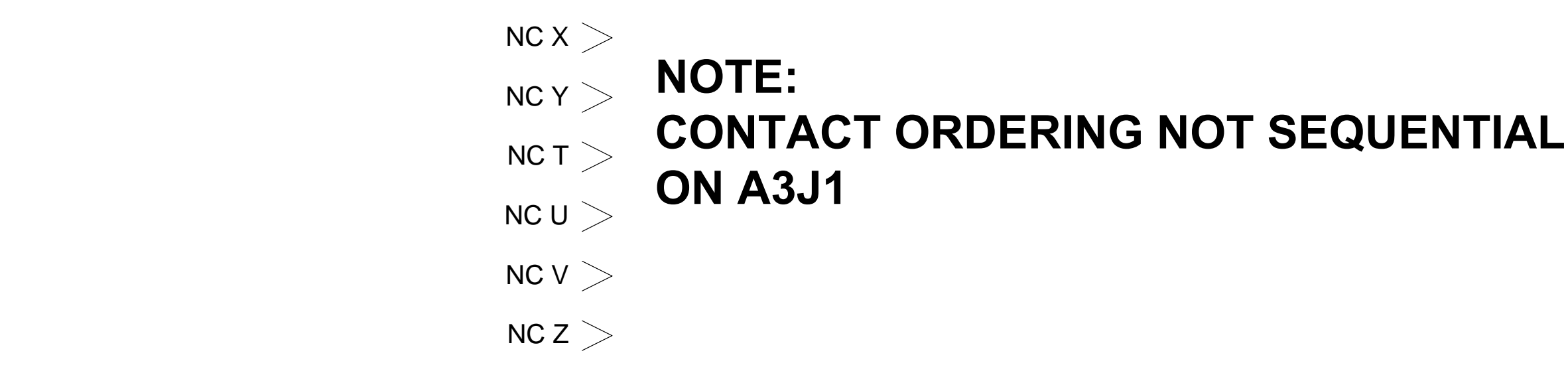
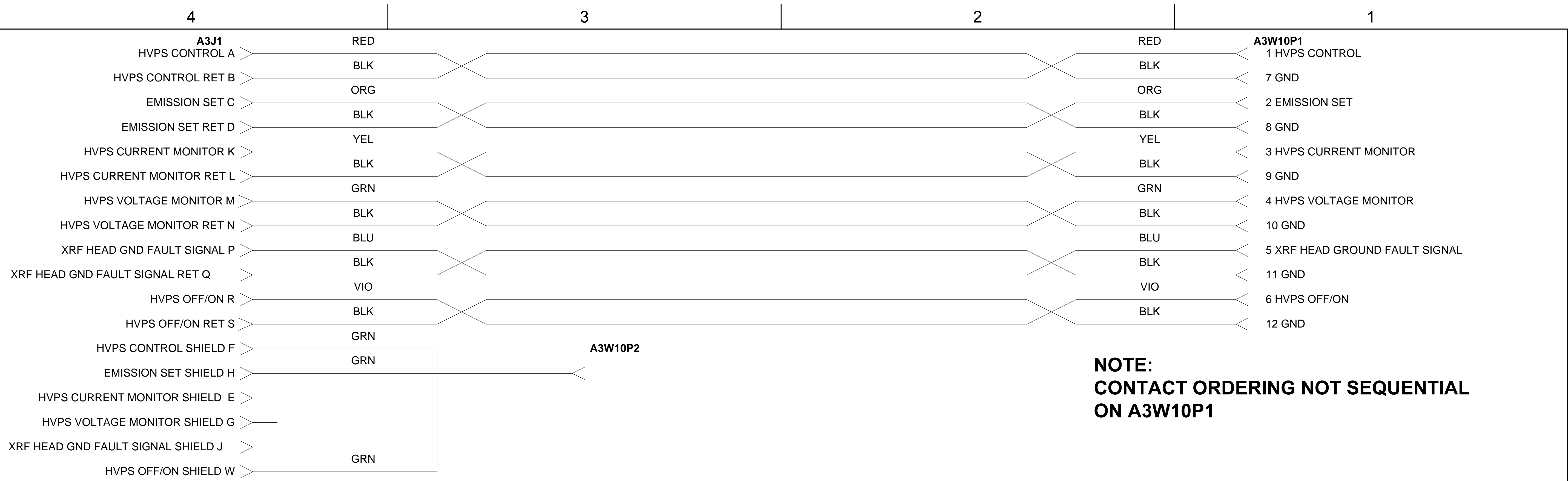

AMPHENOL
BULKHEAD CONNECTOR
MIL-SPEC. SOCKET, FEMALE
24 CONTACT
97-3102A-24-28S

24-28
24#16
INST.

CONTRACT NO.		 APPLIED PHYSICS LABORATORY UNIVERSITY OF WASHINGTON SEATTLE WASHINGTON		
DRAWN BY SABIN				
FILENAME BOREHOLE XRF PROTOTYPE CABLE ASSEMBLY DIAGRAMS REV1.14.VSD	SIZE B	CAGE CODE 98514	DWG NO XXXXXX	REV
DATE 31MAY2007	SHEET 1 OF 1			

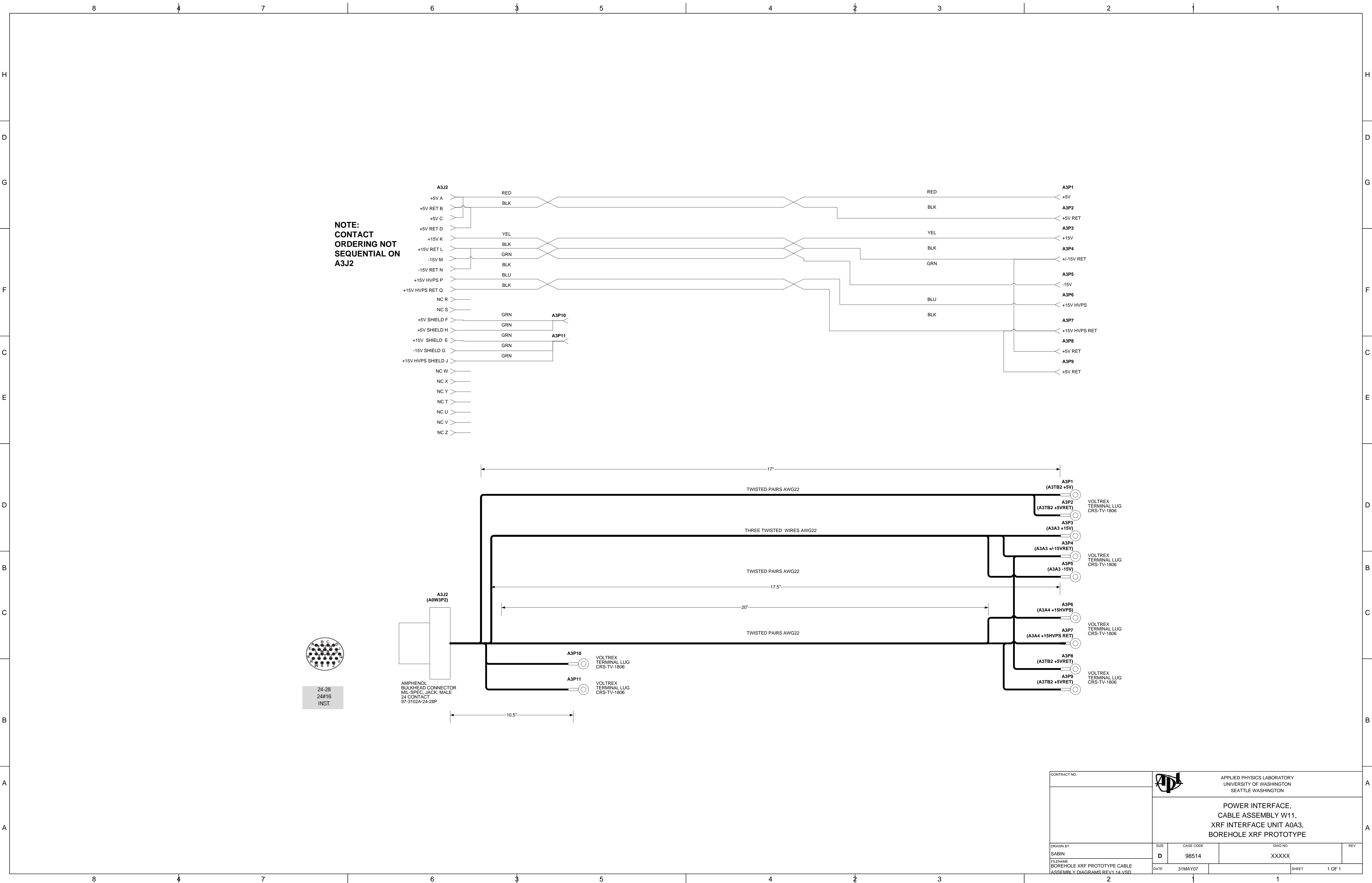

**NOTE:
CONTACT
ORDERING NOT
SEQUENTIAL ON
A3J2**

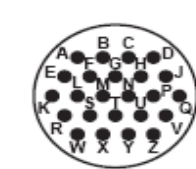

24-28
24#16
INST.

A3J2
(A0W3P2)
AMPHENOL
BULKHEAD CONNECTOR
MIL-SPEC. JACK, MALE
24 CONTACT
97-3102A-24-28P

A3P10
VOLTREX
TERMINAL LUG
CRS-TV-1806

A3P11
VOLTREX
TERMINAL LUG
CRS-TV-1806

CONTRACT NO.		APPLIED PHYSICS LABORATORY UNIVERSITY OF WASHINGTON SEATTLE WASHINGTON	
POWER INTERFACE, CABLE ASSEMBLY W11, XRF INTERFACE UNIT A0A3, BOREHOLE XRF PROTOTYPE			
DRAWN BY SABIN	SIZE D	CAGE CODE 98514	DWG NO. XXXXX
FILENAME BOREHOLE XRF PROTOTYPE CABLE ASSEMBLY DIAGRAMS REV 14 VSD	DATE 31MAY07	SHEET 1	REV 1 OF 1